

NOVEMBER 1972

# BME

BROADCAST MANAGEMENT/ENGINEERING

PR

## TEST EQUIPMENT

Indiana University  
NOV 10 1972  
Library



NOT TYPE APPROVED



**Man's Judgment Poor  
Guide to Signal Quality**

IN 47401



# The Reel Workhorse



Every professional sound recording application needs a recorder/reproducer that assures peak performance each and every time it's used. A heavy duty machine with a built-in reputation for reliability. A machine that will work when others won't and will keep on working when others can't.

The new Telex 1400 Series are such machines. They've added a new dimension in design features to the rugged reliability of the Magnecord 1000 Series that fathered them. The result is the optimum combination of today's technology with field proven dependability.

But these units don't just outwork and outlast other recorder/reproducers. They also outperform anything else in their class. How many recorder/reproducers starting at under \$1500 have a DC servo drive system to assure a timing accuracy of less than 1 second deviation in a 30 minute program, keep flutter and wow at a bare minimum and work with any AC power source?

How many others in this class have a three-speed drive system (3 $\frac{3}{4}$ , 7 $\frac{1}{2}$ , and 15 ips); a catenary head block design with polished, hyperbolic contour heads; a high frequency bias oscillator for maximum S/N ratio; VU meters to monitor record, playback, or bias levels; complete remote control capability; separate gain controls for mic and line inputs as well as a master gain control—to give each machine the potential of a small mixer?

All of this performance capability is kept in long-lasting, smooth operation by total solid state controls, logic circuits that make tape spill virtually impossible, a durable die-cast transport frame, and a host of other heavy-duty and failsafe design features that make Telex 1400's workhorses in any operation.

With dual or single channel options and the availability of all standard head configurations, there's a Telex "reel thing" for every application. Write for free information.

PRODUCTS OF SOUND RESEARCH

## TELEX<sup>®</sup>

COMMUNICATIONS DIVISION

9600 ALDRICH AVENUE SOUTH • MINNEAPOLIS, MINNESOTA 55420

CANADA: DOUBLE DIAMOND ELECTRONICS, LTD., Scarborough 4, Ontario  
EUROPE: ROYAL SOUND COMPANY, INC., 409 North Main Street, Freeport, N.Y. 11520 U.S.A.  
INTERNATIONAL: TELEX EXPORT DEPT., 9600 Aldrich Ave. So., Minneapolis, Minn. 55420 U.S.A.

Circle 100 on Reader Service Card

[www.americanradiohistory.com](http://www.americanradiohistory.com)





# Add this free book on video cable transmission to your technical library

Published by DYN AIR, this book covers problem areas such as hum, equalization, resolution/bandwidth, balanced-line transmission and many others. This is a limited printing . . . order your copy today.

Yes, for a limited time only, you can receive a free copy of this helpful new book, with absolutely no obligation! Just mail the coupon, use the literature request card or drop us a note and we'll reserve a copy for you.

Published by DYN AIR, a pioneer in the field of solid-state video cable transmission equipment, this book covers in detail the problems encountered with routing video through cables . . . and presents the solutions!

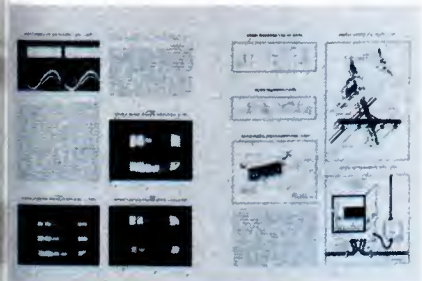

The photographs shown are sample pages reproduced directly from "Video Transmission Techniques" and are typical of the material presented. Pictorial diagrams, supported by easy-to-understand text and numerous photographs, charts and tables, make system design simple.

This book includes useful design information for a multitude of systems, both unbalanced and balanced . . . simple and complex. It covers everything from cable types to complex electronic terminations. The problems involved in selecting the

equipment for a particular application are discussed with the exact equipment detailed for many systems.

DYN AIR video transmission equipment is installed in numerous facilities throughout the world. We have supplied systems for transmitting video information over many miles of cable. DYN AIR systems are available with video bandwidths as great as 30 MHz, providing optimum high-resolution performance.

The practical building-block construction techniques used in solid-state DYN AIR equipment allow systems of virtually any size to be easily assembled. Plug-in modular etched circuit boards are used in most cases, assuring ease of maintenance. Equipment can be provided to suit almost any system requirement.

DYN AIR also manufactures a variety of other solid-state television equipment, including modulators and demodulators, video and pulse amplifiers, local and remote-control switching systems, switcher-faders,

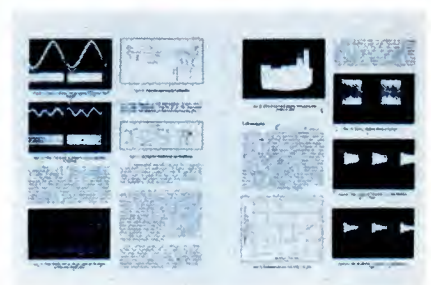
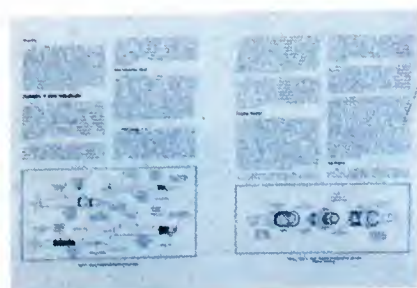

special effect generators, sync generators and sideband analyzers.

If you use this type of equipment, you might like to receive either our complete catalog or literature on specific devices; DYN AIR product information is available upon request —just write, outlining your needs.

**DYN AIR**

**DYN AIR ELECTRONICS, INC.**

6360 FEDERAL BLVD., SAN DIEGO, CALIF.  
ZIP 92114 PHONE (714) 582-9211

Please send free copy of "Video Transmission Techniques"

Have you seen "Video Switching Techniques"?

Yes  No

NAME \_\_\_\_\_

TITLE \_\_\_\_\_

COMPANY \_\_\_\_\_

ADDRESS \_\_\_\_\_

CITY \_\_\_\_\_

STATE \_\_\_\_\_ ZIP NO. \_\_\_\_\_

Circle 101 on Reader Service Card



Unfortunately, the principle piece of equipment found in too many stations is a technician. Better stations are better equipped. See story page 34.

**BROADBAND INFORMATION SERVICES, INC.**  
274 Madison Ave.  
New York, N. Y. 10016  
212-685-5320

Editor

**James A. Lippke**

Associate Editor

**Robin Lanier**

Contributing Editor

**M. L. H. Smith**

Assistant Editor

**A. E. Gehlhaar**

Art Director

**Gus Sauter**

Production Manager

**Arline G. Jacobs**

FCC Counsel

**Pittman Lovett Ford  
Hennessey and White**

Advertising Director

**Charles C. Lenz Jr.**

**6 Broadcast Industry News**

First pay-TV on cable begins

**16 Interpreting the FCC Rules and Regulations**

TV programming during evening hours—"The Prime Time Access Rule"

**21 For Non-Technical Managers: How To Give Your Program Format Technical Support**

Know the basics of amplitude modulation

**24 Solve The Cart Phase Problem With "Instant Alignment"**

An interim step until you can afford better carts

**29 Some Points on Care and Design of FM Antenna Systems**

Too many people ignore the antenna. Do you?

**30 An Automated Measurement System For Vertical Interval Test Signals**

ANSWER is the answer to quality control

**34 Too Many Stations Have Too Little Test Equipment**

Results of survey; recent new equipment

**41 Broadcast Equipment**

New and significant products for broadcasters

**52 New Literature**

Useful reading materials

---

**CM/E MAGAZINE: For those with cable interests/Following page 40**

---



BM/E, BROADCAST MANAGEMENT/ENGINEERING, is published monthly by Broadband Information Services, Inc. All notices pertaining to undeliverable mail or subscriptions should be addressed to 274 Madison Ave., New York, N.Y. 10016. BM/E is circulated without charge to those responsible for station operation and for specifying and authorizing the purchase of equipment used in broadcast facilities. These facilities include AM, FM, and TV broadcast stations; CATV systems; ETV stations; networks and studios; audio and video recording studios; consultants, etc. Subscription prices to others: \$15.00 one year, \$25.00 two.  
Copyright © 1972 by Broadband Information Services, Inc., New York City.  
Controlled Circulation postage paid at East Stroudsburg, Penna.



# DISTRIBUTION AMPLIFIERS

GVG has a complete line of Television Signal Distribution Amplifiers for virtually any purpose. Each distribution amplifier provides four outputs and plug-in interchangeability to a GVG frame.

Model 901 Video Distribution Amplifier ■ Model 902 Clamping Video Distribution Amplifier ■ Model 901DP Video Distribution Amplifier with Differential Input and Plug-In Cable Equalization ■ Model 903P Clamping Video Distribution Amplifier with Differential Input and Cable Equalization ■ Model 903N Clamping Video Distribution Amplifier with Separate Video and Chroma Gain Controls ■ Model 906 Video Distribution Amplifier with Automatic Gain Control ■ Model 907 3.58 MHz Subcarrier Distribution Amplifier ■ Model 910 Pulse Distribution Amplifier ■ Model 912 Pulse Delaying Distribution Amplifier.

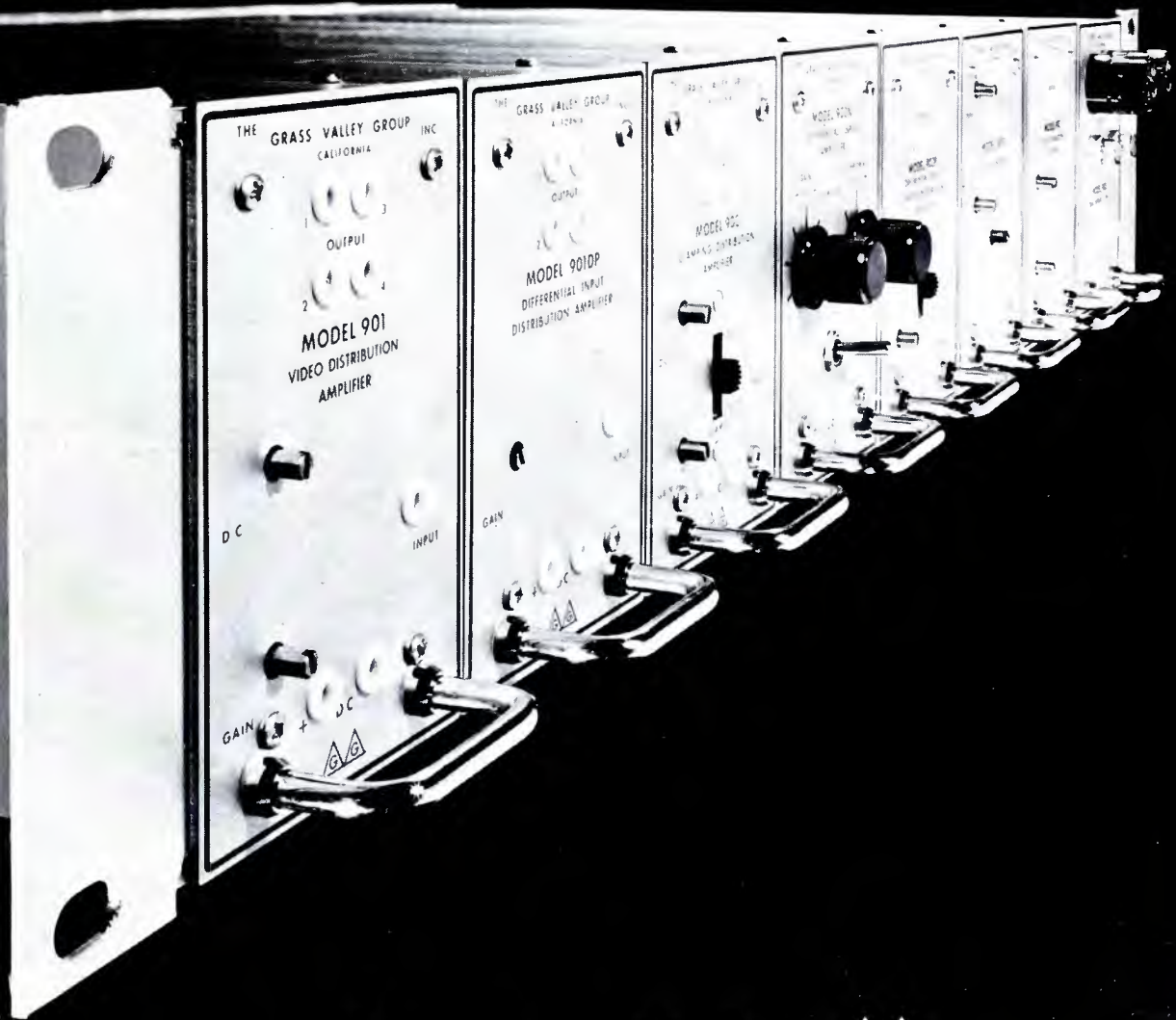

THE GRASS VALLEY GROUP, INC. 

SOLD EXCLUSIVELY BY GRAVCO SALES, INC.

6515 Sunset Blvd.  
LOS ANGELES, CALIF.  
(213) 462-6618

Station Plaza East  
GREAT NECK, N.Y.  
(516) 487-1311

125 South Wilke Road  
ARLINGTON HEIGHTS, ILL.  
(312) 394-1344

Redbird Airport  
DALLAS, TEXAS  
(214) 330-1245

1644 Tullie Circle, N.E.  
ATLANTA, GEORGIA  
(404) 634-0521

Circle 102 on Reader Service Card

# BROADCAST INDUSTRY NEWS

## First Pay-TV On Cable Starts in San Diego

The first pay-TV system that uses channels leased from a cable operator, called "Channel 100," went on line in San Diego, California, in September. Optical Systems Corporation of Los Angeles, parent of Channel 100, has leased channel space from Mission Cable TV, and is offering cable subscribers in the San Diego area a very extensive range of programming available through tickets purchased and inserted in a "black box" attached to the TV receiver. Geoffrey M. Nathanson, president of Optical Systems, says that the firm will offer 80 to 90 motion pictures a year on

sports events, home study in languages, cooking, musical instruments and many other topics. Movies will ordinarily play for an entire week, and a single ticket entitles the customer and his family to see the movie as many times as they want during the week. Cost will vary depending on the program: movies will cost \$2.25 a week for individual tickets, or \$1.50 a week on a season-pass basis. Other services offered will be previews of coming attractions, news, weather, stock market reports, and a high-fidelity music service with four channels of stereo music—classical, rock, easy-listening, and country. Tickets are sold at several ticket offices in the area, or can be ordered by mail.

## First Demo of MCA Video Discs in December

Another video disc, this one using laser-beam scanning of the grooves on the surface, makes its first public appearance on December 12 at the headquarters of the developer, MCA Inc., in Universal City, California. Lew R. Wasserman, president of MCA, Inc., said in the announcement that the demonstration was to be a "progress report" rather than the introduction of a ready consumer product. The MCA disc will bring to at least five the number of video discs now in preparation. The first was the Teldec disc, unveiled two years ago; others are known to be in the works at RCA, Zenith, and Philips.

## Join Network For Success in AM, Says CBS Exec

The president of the CBS Radio Division, Sam Cook Digges, told a meeting of CBS affiliates that membership in the network is the key to success for an AM station. He described a recent study of top markets which identified 15 stations, each of which had 20% or more of the potential audience. Twelve were network stations and five of those were CBS affiliates, he said. He also cited the fact that more than half of CBS affiliates in highly competitive markets were first, second, or third in their markets. "Our business is news," he noted, "and it's our job to supply you with news programming that surpasses in quality that of any other network."

## Design Concepts Issues Computer Package for Cable

Computer packages which provide cable firms with detailed billing, cost accounting and market analysis services have been developed by Design Concepts, Inc. of New York, a company announcement says. Called the CATV-MIS, the

continued on page 8

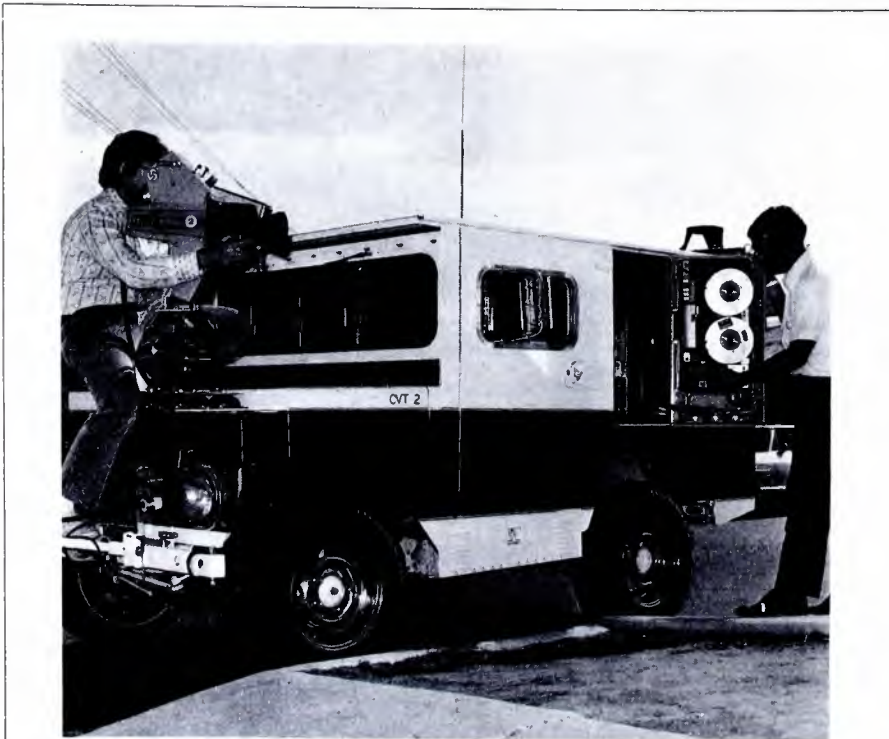

Video Production Vehicle, above, built by Compact Video Trucks, Inc., was used by Metromedia Productions to produce "Sandcastles," the first movie for television to be videotaped using the single-camera technique. Camera was a PCP-70. On-location taping was done with a highband VR-3000 (shown in photo). Editing was done with a CMX off-line computer interfaced with a VR-2000.



# service IS OUR business

A quality cable system is built not only with dependable equipment, but also with professional engineering and reliable service and support. These are the elements offered by Scientific-Atlanta Service Company as the ideal complement to our line of headend, distribution, and two-way terminal equipment. If your plans call for strand mapping, on-site signal evaluation, or system engineering and installation, Scientific-Atlanta has the experience, the people, and equipment you can rely on. Your system is our business.



Boston  
617-272-1256  
Dan Pioli

New York  
201-461-5340  
J. King/J. Levergood

Washington  
301-779-1515  
Ed Pietras

Atlanta  
404-938-2930  
Ben Forrester

Dayton  
913-335-4714  
Dick Gwisdala

St. Louis  
618-397-9251  
Barney Geolat

Dallas  
214-357-1855  
H. Sauter/G. Dent

Los Angeles  
213-428-7515  
Al Gillingham

For more information and a copy of our new catalog write or call Bob Holman, Scientific-Atlanta, Inc., Box 13654, Atlanta, Ga. 30324 Phone (404) 938-2930

## Scientific-Atlanta

Circle 103 on Reader Service Card



# Quality and economy can go together... we did it with Encore tape cartridge equipment



Encore Reproducer \$475

Some broadcasters want and need an economy line of tape cartridge equipment. We incorporated the best features of our premium line into Encore. We simplified systems, circuits and manufacturing techniques. And we created further economies by selling direct, with payment due when you order. We offer a 30-day guarantee of satisfaction plus a one year warranty. Call us collect today and find out why many broadcasters are finding quality and economy under the Encore name.

Encore Recorder/Reproducer \$630



Call 309-828-1381 collect for details on the Encore series

**it** INTERNATIONAL  
TAPETRONICS  
CORPORATION

2425 South Main Street,  
Bloomington, Illinois 61701

Circle 104 on Reader Service Card

## NEWS

systems offer to cover all accounting operations and supply the user with quick analyses of marketing or accounting positions.

### Test and Calibration Tapes Planned by New Company

A comprehensive series of precision test and calibration tapes will be marketed by Magnetic Reference Laboratory, Palo Alto, California, a new firm set up by former engineering executives of Ampex. The principals include John G. McKnight (widely known for his magnetic recording development work at Ampex and for leadership in establishing magnetic standards through the Audio Engineering Society), Antonio Bardakos, and William E. Seamon. Tapes now ready include one for azimuth alignment using a "self-checking difference" method.

### NAB Head Attacks Proposed Ban On Proprietary Drug Ads

The proposal to ban broadcast advertising of non-prescription drugs, allegedly to help deal with the nation's drug problem, was called a "shabby fraud" by Vincent T. Wasilewski, president of the National Association of Broadcasters.

Speaking before the Nevada Broadcasters Association, Mr. Wasilewski noted that cigarette use was at an all-time high, in spite of the ban on cigarette advertising on the air waves. He said a similar ban on drug ads would have no effect on the roots of the drug problem. He said the action would be "... a pretence designed to divert people's attention from the real problem."

### KFYR, Bismark, Uses Computer To Schedule Spot Ads

Greatly improved control of the scheduling of spot commercials through the use of a computer, the IBM System/3 Model 6, is reported by Meyer Broadcasting Company, operator of KFYR in Bismark, North Dakota. The company operates three television stations, three FM radio stations, and two AM stations in the area, with substantial numbers of listeners in five states and two Canadian provinces.

"Media buying has become a highly sophisticated business," said William Ekberg, president of the firm. "The advertisers want specific time slots, and want to know what programs or commercials precede

and follow the slots . . . with computer scheduling . . . we can assure that they get maximum coverage . . . We can rotate the message to different time slots." The computer does the rotating automatically which would be nearly impossible manually with 600 to 700 spots weekly. The computer also carries out major accounting operations for the firm.

### Ohio University TV Asks Public To Bring In Program Skills

Ohio University's TV station, WOUB, has invited viewers to come in with any talents they have in craft-making, singing, dancing, and other performing arts, or if they just have something they want to say that might interest a general audience. Auditions will choose performers for "RFD," a community affairs program which began its second season in October. The weekly half-hour program is presenting regional reports, Appalachian history, consumer information, profiles of people, area arts and culture, as well as viewers' opinions. Anyone interested should contact WOUB's Program Department at Ohio University Broadcasting, Athens, Ohio.

### Metromedia Radio in Capital Gives Candidates Free Time

WASH, the Metromedia radio station in Washington, D.C., will continue a policy begun in the recent primaries of giving free air time to all legitimate political candidates. William Dalton, vice president and general manager, said the station would not sell advertising to candidates but would invite them to record political messages for broadcast.

### Church Group Says Stations Should Be Free to Pay Minority Advisers

The Office of Communications of the United Church of Christ, a leader in encouraging minority groups to seek representation in broadcast operation and programming, holds that broadcasters should be allowed to pay minority-group advisers for their services. The opinion was expressed in a letter to the FCC which has asked for comment on that point. The church group said that fears of a "shakedown" were grossly exaggerated, and that the people who could be of most use to the broadcaster in the minority area usually could not

continued on page 10

Circle 105 on Reader Service Card →



# FASTEST HANDLING SINGLE SYSTEM SOUND CAMERA IN THE WORLD.

Canon Sound Scoopic 200. A single system sound-on magnetic news documentary camera. Designed for the TV news cameraman. Without compromise. And with features long demanded . . .

**REFLEX VIEWING** through a 135° rotating mirror shutter. No beam splitter. **No loss of light at the film plane.**

**FULLY AUTOMATIC THRU-THE-LENS METERING** with manual override control. F stops visible in the viewfinder. Instant open and return diaphragm for fast focusing.

**FILTER SLOTTED** 12.5-75mm Canon zoom lens. Filter changeable in seconds.

**REGISTRATION PIN MOVEMENT.** Assures perfect framing.

**ELECTRONICALLY GOVERNED MOTOR.** Insures accurate sound speed.

**MODULAR TWIN SOUND HEADS.** Snap in and out in seconds.

**LIGHT WEIGHT.** 12 lbs. 6 oz. Including body with film chamber, lens, exposure system, sound heads and take-up spools.

**LOW PROFILE** bottom load design for 200 feet daylight spools. Shoot from cars, doorways . . . anywhere.

**AND MORE.** A 6 lb. 14 oz. over-the-shoulder amplifier/camera power pack in a single unit. With advanced automatic gain control with manual override. VU meter. Dual mike input. And a fast rechargeable battery that powers the camera, meter and amplifier through 2000 feet of film. Recharges in under 5 hours. Batteries interchange in seconds.

Feature for feature, Canon Sound Scoopic 200 adds up to getting the news faster than ever. See it in action at your Canon dealer. Or write us for more information.



Sound Scoopic 200

**New New New**  
**Come out of the dark with great shots!**  
We've widened our rotating mirror shutter angle from 135° to 170° for more direct light to the film. And we've changed the lens opening from 2.5 to 1.8. Now you can shoot in much darker areas than ever before.  
At Canon we make good things even better.

**Canon**  
SOUND SCOOPIC 200  
Canon USA, Inc.  
Nevada Drive Lake Success  
New York 11040



Dear Gabby:

# "How can a wife compete with a \$10,000 Video Tape Editing System featuring Jam-Sync?"



Datatron's Girl Gabby

**DEAR GABBY:** My husband returned from the NAB show singing the praises of a \$10,000 Video Tape Editing System which features something called 'Jam-Sync'. Since he seldom praises my homemade jams, or notices the hours I slave over the kitchen sink, I need help in winning him back.

**DEAR NEGLECTED:** Many NAB visitors fell in love with Datatron's Model 5050 - a Video Tape Editing System with keyboard entry which works with helical or quadruplex VTRs, yet is priced at \$10,000, thousands under competition. In fact, a number of TV stations placed orders right at the show.

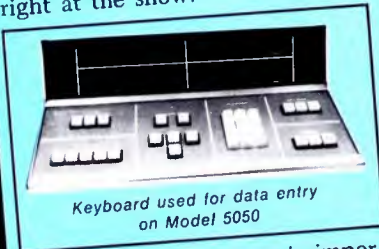

Keyboard used for data entry on Model 5050

The jam-sync feature is important since it eliminates the need to pre-record the SMPTE time code on tapes for add-on editing from masters or live sources.

Instead, during pre-roll, the built-in time code generator is set & sync'd so that time picks up exactly where it left off - to the

frame! This saves hours of time, and head wear on expensive video recorders too.

But don't fret. Once your husband's Datatron Model 5050 is installed, he'll have more free time to sing the praises of your jams and jellies.

GABBY

★ ★ ★

**DEAR GABBY:** How can Datatron sell a SMPTE edit code reader for \$1500 and a generator for \$1750 when competitive models go for over \$2500?

**AFRAID OF BARGAINS**

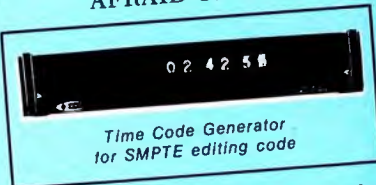

Time Code Generator for SMPTE editing code

**DEAR AFRAID:** Don't be afraid of these bargains. Datatron's edit code reader & generator are fallouts from their Video Tape Editing System project. The low prices reflect simple construction and dedicated design. Actually, they cost less than capstan revolution counters which aren't nearly as accurate.

GABBY

★ ★ ★

Send your questions - either straight or humorous - to Gabby. We'll mail a Flair pen for all received and pay \$100 if we use question in future ad.

## datatron inc.

1562 Reynolds Ave / Santa Ana, Calif. 92711  
(714) 540-9330

moving up fast in...



Microelectronic Testing



Timing Instrumentation



Shelly Indicators and Readouts

Circle 106 on Reader Service Card

## NEWS

afford to give large amounts of time without compensation.

### WJAR, At 50, Shows How Radio Succeeds Today

WJAR-AM in Providence, Rhode Island, celebrating its fiftieth anniversary, says prospects for radio were never better. Focus of the celebration was a party for 600 advertisers, agency executives, and network officials on September 8. WJAR's success formula, as explained by Allen Andrews, general manager, includes accent on news and informative talk shows during the day and music during the late night and early morning hours. "WJAR has found a strong, flexible program identity in its 'news and information' accent," he said. "Radio is still a tough sell, but advertisers are . . . more aware of radio's impact now than (at any time) since the Golden Age of Radio (before television)."

### Gateway Buys Seven Stations From Triangle Publications

The FCC has approved the transfer of seven broadcast properties from Triangle Publications, Inc., to Gateway Communications, Inc., in a move to bring Triangle into line with the multiple-ownership rules of the FCC. The stations are WFGB-TV, Altoona, Pa.; WLYH-TV, Lancaster-Lebanon, Pa.; WNB-FM and WNB-FM, Binghamton, N.Y.; WFGB and WFGB-FM, Altoona, Pa.; and WNB-FM Triangle already owns cable interests in the Altoona and Lancaster-Lebanon areas.

Under the agreement Gateway will retain the television stations and spin off the Altoona radio stations to the Gilcom Corporation, the Binghamton radio stations to Stoner Broadcasting. Neither Gateway nor Gilcom had any previous broadcast or cable interests. Gateway is a new corporation, its major stockholder being the Bergen Evening Record Corp., publisher of newspapers in Hackensack and Paterson, N.J.

### Tape Industry Headed for High, Says Certron President

The magnetic tape industry will set records in 1973 in the opinion of Edwin Gamson, president of Certron Corporation. "The boom that everyone talked about in the 1960s is finally starting to materialize," said

continued on page 12



# See what



Display illustrated is the frequency response characteristic of a 20 Hz to 20 KHz filter from 10 Hz to 50 KHz over a 60 dB dynamic range. Waveform at right shows the resonance of the same filter with sensitivity increased 40 dB.

# you can't quite hear

Harmonics, noise and hum don't mask peaks and nulls in audio frequency response measurement when you use the Systron Donner 711/801B Spectrum Analyzer. The coherence of the tracking oscillator output and the analyzer scanning signals assure it.

The variable persistence CRT display of the 711/801B lets you store signals up to six hours. You can study audio frequency signals that need slow scan rates for high resolution. Or you can retain intermittent or varying signals for later visual analysis or photography.

You can choose **logarithmic** or linear frequency scan from 10 Hz to 50 KHz with the 711/801B. Frequencies may be measured within 1% throughout the linear frequency range.

At \$4,995, there's no more useful instrument for many audio measurements in the lab or on the production line. Ask your nearest Scientific Devices Office for a demonstration, or contact Microwave Division, 14844 Oxnard Street, Van Nuys, California 91409. Phone (213) 786-1760.

**In Europe:** Systron-Donner GmbH, Munich W-Germany; Systron-Donner Ltd., Leamington Spa U.K.

**MICROWAVE  
DIVISION**

**SYSTRON  DONNER**

**The Systron-Donner Instruments Group:**

Computer Systems  Concord Instruments  Datapulse  Kruse Electronics  Microwave  Trygon Electronics

Circle 107 on Reader Service Card



# Down With Co-Channel Interference.

Tracor's 6500 Visual Carrier Generator System is available "on frequency." Or with a  $\pm 10,010$  Hz offset. *Unattended*, it keeps your station within .05 Hz per year. Frees your engineers from slavery. Provides larger audience with better reception. FCC approved, this rubidium-based system is already in wide use. For the inside story, call (512) 926-2800 today. Or write, Tracor Inc., Industrial Instruments, 6500 Tracor Lane, Austin, Texas 78721

**TRACOR**  
Free The People  
Box.



Circle 108 on Reader Service Card



... for LPB's  
mini-studio systems, delivered

complete and ready  
for on-air, recording

studio or remote operation. Included are:

- Console.
- 2 Professional 3-speed 12-inch Turntables.
- 2 12-inch Tone Arms.
- 2 Stanton Cartridges, with Styli.
- Turntable Equalizer/Preamplifier . . . 2 for stereo.

Nine systems to choose from . . . each with sturdy, handsome, white Formica® top furniture over blue textured finish steel legs and supports.

Other dj8 systems start as low as \$1225. The compact dj5 systems from \$1125.

LPB offers a complete line of broadcast audio equipment. Call or write us for all your audio needs, from mike stands to headphones.



LPB Inc.  
520 Lincoln Highway, Frazer, Pa. 19355 (215) 644-1123  
In Canada: P.O. Box 669, Orleans, Ontario (613) 824-3232

Circle 109 on Reader Service Card

## NEWS

Gamson. The biggest increase in the last year has been in cassette sales but eight-track is also enjoying a major resurgence, according to Gamson. Certron manufactures equipment for all standard tape formats, concentrating heavily on what it believes is the prime growth area—the youth market.

### Central Europe AES Meets February in Rotterdam

The Central Europe Section of the Audio Engineering Society will hold its third annual convention in Rotterdam, Holland, on February 20, 21 and 22, 1973. Included will be a program of technical papers and panel discussions, and an exhibition of new audio products by manufacturers from many countries. The Central Europe section has members in most countries of Europe and the convention is expected to draw participants from all of Europe, as have the two earlier conventions. American engineers and firms may get information about the convention from the Audio Engineering Society, 60 East 42nd St., New York 10017.

### Tele-Poll Gives Overnight Market Data

A new opinion-sampling service, Tele-Poll, of Beltsville, Md., has begun supplying overnight marketing surveys and opinion polls by a telephone interview system. According to an organization announcement, about 3000 telephone interviewers across the country develop the data through questions with multiple-choice of "yes-or-no" answers. A number of political candidates, as well as businesses seeking market data, are using the service, the announcement said.

### Engineers' Union Agrees on New Computer, Automation Rules

The International Brotherhood of Electrical Workers, which represents more than 1200 radio engineers, has approved a new contract form which includes precedent-setting provisions on automation, computer data entry, and graphics. For example, a new section says: "Electronic special effects and graphics can be set up and changed by any station personnel if the

continued on page 53



# Get the professional look from helical-scan Ampex **VPR-7950** It's that good!

A super-sharp teleproducer can see the superior quality of a VPR-7950 picture compared to one from any other 1" recorder.

## What is a VPR-7950?

The world's highest performance 1" color/monochrome, helical-scan videotape recorder. It incorporates the same advanced design features of the Ampex VPR-7900 and the TBC-790 time base corrector in a handsome, highly functional console.

Video waveform and picture monitor selector switches may be used together or independently. An eye-level panel includes both monitors as standard equipment and an optional vector display scope.

The VPR-7950 is a complete recorder/reproducer which features:

- Very high carrier mode (7-10 MHz) for exceptional quality in color dubs even down to 3rd and 4th generations; 5th, in black and white.
- Precision, fast, *total*, electronic insert and assemble editing from any signal source.
- Internal digital reference system that includes a horizontal lock servo, frame lock and vertical interval switching.
- Three independent tracks (single video - dual audio), each of which can be used, altered, edited or replaced at any time.
- High efficiency ferrite video head with 500 hour warranty and the fastest, simplest replacement system ever devised.
- Capstan controlled high speed tape cycling modes, velocity loop tension servo, direct coupled drum servo, minutes and seconds coun-



ter, monitor amplifier and cue microphone.

In developing the time base corrector, Ampex engineers discarded current technology and took a new



*Ampex VPR-7900 recorder/reproducer  
with TBC-790*

Circle 110 on Reader Service Card

digital approach to time base correction that affords the most stable video signal ever produced by a helical-scan recorder. It produces clean fades, lap dissolves and special effects as well as dubs of edited material of outstanding quality to 1" and 1/2" videotape recorders, quadruplex recorders and transfers to film.

Like the VPR-7950, the combination of the VPR-7900 and TBC-790 produces recording capabilities that meet all standard broadcast requirements. The TBC-790 may be purchased with the VPR-7900 you may now own. The VPR-7900/TBC combination is portable enough for use as a mobile unit for location work. Tapes made on the VPR-7900 are completely interchangeable with those made on the VPR-7950.

Round out your teleproduction system with the Ampex CC-500 color camera system, which incorporates professional features, is simple to operate and low in price.

*CC-500 Camera*



Call your Ampex Dealer or write: Audio-Video Sales, Ampex Corporation, 401 Broadway, Redwood City, CA 94603.

**AMPEX**



Norelco's New PC-72:

# The Green

An innovative  
new 3-Plumbicon  
color camera  
that eliminates

- Camera mismatch
- Cable mismatch
- Color mismatch





# Mini Killer

The innovators at Norelco introduce today's most advanced color camera in its price range. Not an updated model. A new generation. It kills many stubborn problems that have tormented video production men for years. And its CLUE feature helps you get better performance from other cameras you already have.

With the latest solid state circuit technique and modular design, the PC-72 achieves new standards of stability, reliability, and ease of maintenance. Plus three major new standard features you can't find in other cameras.

#### **CLUE for quick, precise set-up and camera matching.**

CLUE allows you to set up accurately and more easily without a waveform monitor. Using a black and white monitor,

CLUE compares alternate scan lines from the red, green and blue signals. Peak white, black levels and gamma tracking in the color channels are quickly and accurately adjusted

for optimum color balance. CLUE allows the same reference to be used to match between cameras.

Presto, your cameras are set up and matched in a fraction of the usual time!

**Precise compensation for standard cable, mini cable or any combination of both.** Now ringing and smearing from cable mismatch disappear. It's as easy as dialing a phone. The PC-72 operates with up to 3,000 feet of standard cable or 2,000 feet of mini. Mix 'em up in the line if you like. Just dial the footage of each into the camera. Presto, perfect camera/cable compensation!

**Pre-set pushbutton varichrome variable matrixing holds the color the sponsor wants on every shot.** Varichrome gives independent remote control of hue and saturation settings for all primary and secondary colors. Without affecting grey scale. Once you've decided the settings you want to compensate for lighting from each camera angle, your final take is routine. Just push a button for each angle. Presto, the color you want in every shot!

**Bias light—no lag at low light levels.** Bias lighting, *adjustable individually* in Red, Green and Blue, virtually eliminates lag at low light levels.

**And—scene contrast compression.** A flick of a switch and scene contrast compression brings out detail lost in shadowed areas...without loss of highlights.

**Take your last look at color gremlins... write now for complete information on the new-generation PC-72.**

\*Reg. TM N. V. Philips of Holland

**Norelco**

PHILIPS BROADCAST EQUIPMENT CORP.  
A NORTH AMERICAN PHILIPS COMPANY

One Philips Parkway  
Montvale, N.J. 07645 • 201/391-1000



# INTERPRETING THE **FCC** RULES & REGULATIONS

## **TV Programming During Evening Hours – “The Prime Time Access Rule”**

Commission inquiries into network programming date back to 1959 when a study was initiated into network program procurement policies. On March 22, 1962, the Commission issued a rule making notice proposing that networks be limited to ownership of 50% of prime time programming; excluded from domestic and foreign syndication of independently produced programs and prohibited from acquiring additional rights in programs independently produced for network showing. Oral argument was held on July 22 and 23, 1969 on the proposals. While it was not adopting the 50/50 rule, the Commission said it was not closing the docket and would keep it in abeyance.

Finally, on May 4, 1970, the Commission issued a Report and Order (Docket 12782) containing rules (Section 73.658) restricting (a) network ownership and syndication of television programs, and (b) the amount of network programming stations in the top 50 markets may carry during prime time.

The new rules specify that, after October 1, 1971, television stations in the top 50 markets, where there are three or more operating commercial TV stations, may not broadcast more than three hours of network programming during prime time—7 to 11 p.m. (6 to 10 p.m., Central time). Special news programs involving 1) fast breaking events, 2) on-the-spot coverage of news events, and 3) political broadcasts by legally qualified candidates are excluded from this limitation. (Non-commercial stations and networks are exempt.)

The portion of the time from which network programs are excluded may not, after October 1, 1972, be filled with off-network programs or feature films which, within two years prior to date of broadcast, had been previously broadcast by a station within the market.

After October 1, 1970, networks will be prohibited from acquiring subsidiary rights and interests in programs produced by any source other than themselves. They are also prohibited, after October 1, 1971, from syndicating any programs for non-network showing in the United States, and may not sell, license, or distribute television programs of which the network is not sole producer for exhibition outside the United States.

A new paragraph (j) (4) to Section 73.658

defines the term “network” to mean any person, entity, or corporation which offers an interconnected program service on a regular basis for 15 or more hours per week to at least 25 affiliated television licensees in ten or more states and/or any person, entity or corporation controlling, controlled by, or under common control with such person, entity, or corporation.

A number of “compelling” statistics were cited by the Commission as factors in determining its action. It noted that there are only three national television networks—of the 224 stations in the top 50 markets, 153 were network affiliates; of 621 stations in the entire United States, 499 were network affiliates. Between the hours of 7:30 to 10:30 p.m., network affiliates carried only between 1.2 to 1.6 hours of non-network programs per week and, it pointed out that non-network programming is increasingly made up of programs which originally had appeared in network series.

The Commission said that the three television networks, “for all practical purposes control the entire network television program production process from idea through exhibition.” In the entertainment program category, the number of hours controlled or produced by the networks rose from about 64% in 1957 to over 96% in 1968. Programs produced by independent producers dropped from 33⅓% in 1957 to about 5% in 1968.

Commenting on the relationship of network program production to syndication, the Commission pointed to “substantial increases in the total hours of packager-licensed programs, accompanied by substantial increases in the percentage of such programs in which networks obtained both domestic and foreign profit shares.” It said that while income from this source is not a major part of overall revenues, it is substantial and is increasing. The Commission noted that “a direct relationship appears to exist between new programs chosen for network schedules and network acquisition of subsidiary rights and interests.”

This combination of circumstances has resulted in an “unhealthy situation.” The Commission noted that prime time first run syndicated programs have “virtually disappeared.” It said lack of first run syndicated programs adversely affected the pro-

continued on page 60



# RCA

## PRIME-TIME

### Presenting a whole new world of production ideas.

RCA presents "The Producer"—today's most advanced mix-effects system.

What it can do ranges from simple wipes and dissolves to exciting effects you've got to see to believe.

And what it can mean to your station is a big boost in local production profits.

Innovative, versatile and easy-to-operate, "The Producer" combines the capabilities of the TA-70 Video Mixing and Effects Amplifier and the TE-70 Special Effects System.

You get not only a wide range of conventional effects, but also a variety of first-of-a-kind features, such as halos...non-repeat patterns...adjustable borders in any hue on all patterns...and C-background capability for fading or wiping two other signals while retaining background.

The TA-70 inserts, wipes and dissolves three video inputs. Pushbutton switches on the console panel permit selection of six operational modes: Lap, Effects, Fade-to-Black, A-B Insert, C-Signal Background, and C-Signal Insert.

The control levers function either "locked" or "split" with no home limit restrictions.

The TE-70 System simplifies the selection and execution of effects. For example, Self Key, Matte Key, Chroma Key, Mask Key, Wipe Key, and Key Signal Inversion are easily available.

The TE-70 is placed in control of the TA-70 Mixing and Effects Amplifier with the "Effects" selector button on the mixer control lever assembly.

There are 24 different wipe patterns to select from. And a built-in audio oscillator provides pattern-edge modulation.

The digital design of the pattern positioner prevents overshoot and crawl with no change in size or shape during positioning. An exclusive non-repeat feature allows a pattern to be moved completely off screen without reappearing on the opposite side of the picture. Once the pattern is removed, it can be changed in shape or content or both, and then moved back into the picture at any point—while on-air.

Other features include a border mode for patterns and a halo effect. The width of both border and halo is adjustable.

The capabilities we've mentioned are only a sampling of what "The Producer" can do. Its flexibility of operation means easy adaptability to the needs of just about any TV broadcaster.

How about your station? Think about what you could do with some new dimensions in creative production. Ask your RCA representative.

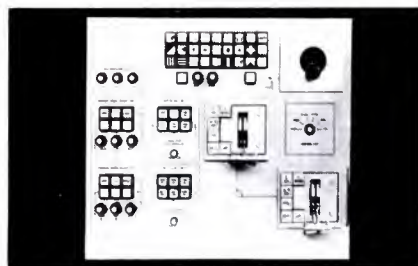

A typical console configuration for the TA/TE-70 mix-effects system. A variety of other arrangements are also available.

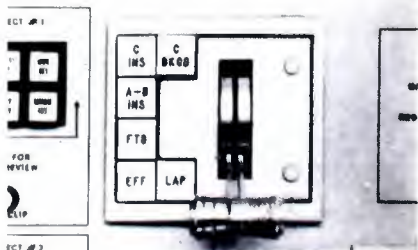

Control-lever assembly includes push-button switches for selection of operational modes. Limit lamps indicate lever "last-on" position.

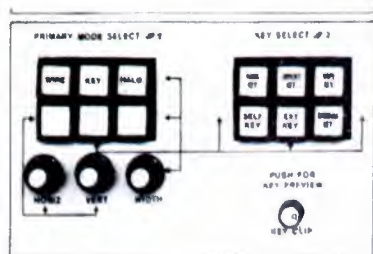

Primary mode/key select panels show the wide range of effects possible.

Circle 111 on Reader Service Card



# "The Producer" produces a low-cost commercial.



1 Exclusive features of the TA/TE-70 can help make effective, eye-catching commercials, even with such a simple background as a 35mm slide.



2 Halo effect has adjustable rim width, can be used to point up important information in the picture.



3 Non-repeat feature allows a pattern to be positioned completely off screen without reappearing on opposite side of picture. This feature also allows male announcer to be "walked" off screen in a diamond pattern.



4 Then female personality can be "walked" on in oval pattern for the ladies' point of view. All while on the air.

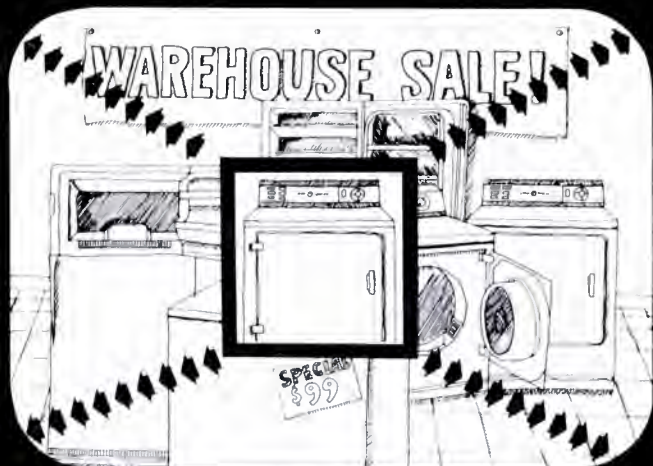

5 Border effect that can be used in any color desired with all patterns. Border width is adjustable.



6 Cutting back to original slide, fade or wipe of two key or matte key sources, such as these titles, can be introduced over the constant background signal.



# All about a TCR-100/TR-60 combo and cost effectiveness at KTSM-TV

The broadcast engineering chief has to be a past master at translating equipment specifications and costs into operational values. So when it came time for station KTSM-TV of El Paso, Texas to purchase an RCA TCR-100 "Cart" machine, Director of Engineering W. T. McGill chose to order the TCR-100/TR-60 combination instead of the lower-cost package of the TCR-100 with a Signal Processing Unit.



Mr. McGill had his reasons. Since KTSM-TV operates in the Mountain Time zone, it must rely on taping network events for rebroadcast. For example, KTSM records the nightly NBC news at 4:30 El Paso time for airing at 5:30. Similarly, the Tonight Show is put on tape at 9:30 El Paso time for playback at 10:30.

To help handle this heavy taping schedule, the TR-60 reel-to-reel machine was assigned to double duty. Part of its circuitry records network program feed while the remainder serves the TCR-100 in a playback role.

Now—four months later—Mr. McGill feels he has been amply justified in his purchasing decision.

Employing the TR-60 in this dual capacity provides the station with another important operational value. It frees the station's TR-70 reel-to-reel tape machines for expanded use in production. As is true at many stations, KTSM's ability to make production tools work harder is becoming increasingly crucial in building revenues. Local commercial business

is flourishing, and Mr. McGill's purchasing decision means the station can compete to better advantage.

The TCR-100/TR-60 configuration has presented no reliability problems. In four months of operation, involving 15,000 TCR-100 cycles, KTSM has lost no commercial time. Maintenance has been accomplished within established norms.

This dependability has enabled KTSM to eliminate backup tapes for ID's, public service announcements, opening and closing of shows, and other promotions. Reassured by the Cart machine's performance, KTSM has already begun to transfer film spots to cartridges. Backup is still

retained for reel-to-reel commercial spots.

At KTSM, the TCR-100 operator gets his programming and loading directions from a daily log printed out by the station's computer. When commercials are repeated within the same machine load, an A-to-B dub is performed prior to loading. This method of operation, to Mr. McGill's way of thinking, is far more satisfactory than "random access" which, he believes, could cause confusion.

Based on his experience so far, Mr. McGill is confident the TCR-100 will help the station not only to take in more, but also to make more on what it takes in.

Circle 113 on Reader Service Card

## TCR-100 Box Score

Number delivered	51
Number of commercials broadcast	763,000*
Present rate (commercials/day)	3,500*
Man hours saved	31,600*

\*Estimate

## TCR-100's Delivered

KHQ-TV, Spokane, Wash.	WECT-TV, Wilmington, N. C.
KIRO-TV, Seattle, Wash.	WFMY-TV, Greensboro, N. C.
KNTV, San Jose, Calif.	WGN-TV, Chicago, Ill.
KPLR-TV, St. Louis, Mo.	WGR-TV, Buffalo, N. Y.
KPRC-TV, Houston, Texas	WISN-TV, Milwaukee, Wisc.
KSLA-TV, Shreveport, La.	WJAR-TV, Providence, R. I.
KTSM-TV, El Paso, Texas	WKBW-TV, Buffalo, N. Y.
KVRL-TV, Houston, Texas	WKRC-TV, Cincinnati, O.
KWTV, Oklahoma City, Okla.	WKYC-TV, Cleveland, O.
NBC, Network, N. Y. C. (3)	WMAQ-TV, Chicago, Ill.
NBC, Network, Burbank, Calif.	WNCT-TV, Greenville, N. C.
WAFB-TV, Baton Rouge, La.	WPTV, West Palm Beach, Fla.
WAPA-TV, San Juan, P. R.	WRAL-TV, Raleigh, N. C.
WBAL-TV, Baltimore, Md.	WRC-TV, Washington, D. C. (2)
WBAY-TV, Green Bay, Wisc.	WSAV-TV, Savannah, Ga.
WBNS-TV, Columbus, O. (2)	WSB-TV, Atlanta, Ga.
WBRC-TV, Birmingham, Ala.	WTAE-TV, Pittsburgh, Pa.
WBRE-TV, Wilkes Barre, Pa.	WTAF-TV, Philadelphia, Pa.
WDAF-TV, Kansas City, Mo.	WTVN, Chattanooga, Tenn.
WDAY-TV, Fargo, N. D.	WTVN, Columbus, O.
WDCA-TV, Washington, D. C.	WUTV, Buffalo, N. Y.
	WWL-TV, New Orleans, La.

Austarama TV, Melbourne, Australia  
 CHAN-TV, Vancouver, B. C., Canada  
 London Weekend TV, London, United Kingdom  
 Venevision, Caracas, Venezuela



# From WKZO about Ampliphase: "Our program people call it 'hi-fi AM radio' "

That's what we hear from Arthur E. Covell, Chief Engineer of WKZO in Kalamazoo, Mich., referring to the station's new RCA BTA-5L, 5 kW Ampliphase transmitter.



The reason for such an enthusiastic notice, and others like it, is that Ampliphase (phase-to-amplitude modulation) delivers clean, crisp sound quality you'd expect from an FM transmitter.

To quote Mr. Covell again on his BTA-5L: "The circuits are very stable, the frequency response is within

1.5 dB from 30 Hz to 20,000 Hz. The total audio frequency harmonic content is 1.2% or less.

"The WKZO antenna is a 4-tower directional antenna which involves a large reactance change across the channel at 590 kc. The 5L transmitter is tolerant to this situation and is switched between the array and the single tower without re-tuning."

Gale Allred, Chief Engineer of KFQD, Anchorage, Alaska, is equally enthusiastic about his new 50 kW Ampliphase transmitter. His comments include these: "In all the 21 years I have been broadcasting, I have worked with different types of rigs... but never have I seen any to compare with your BTA-50J. It has by far the best overall frequency response I have ever seen.

"I made measurements and the frequency response was checked from 30 Hz to 20,000 Hz and it was within 0.5 dB. The distortion was

less than 1.2%. This is without a doubt the best performance I have ever come in contact with. It is a very stable rig... it truly sounds great."

Sound quality isn't the only reason for stations to switch to Ampliphase. Economy counts, too.

For example, the greater efficiency of its amplifying and modulating circuits permits a measurable reduction in primary power. And Ampliphase has taken advantage of solid state technology to improve reliability, reduce power requirements and lower maintenance. The 5 kW Ampliphase transmitter (BTA-5L) uses only four tubes, and the 10 kW (BTA-10L) and 50 kW (BTA-50J) use only six tubes.

The elimination of high power modulators and modulation transformer further reduces power consumption and maintenance. (No audio transformers of any kind are used in RCA Ampliphase transmitters.)

Circle 114 on Reader Service Card

The new *BFG Series* of tri-pole FM Antennas radiate a circularly or elliptically polarized wave, eliminating the need for separate vertically and horizontally polarized antennas.

The ratio of horizontal to vertical polarization may be adjusted at the factory to suit the user's requirements.

They are available in from one to sixteen sections, with total power gains of 0.9 to 17.8 (horizontal plus vertical). Electric de-icing equipment is offered as an optional accessory.

Circle 115 on Reader Service Card



## Products in the news.

RCA PRIME TIME

New *FM Panel Antennas*, for multi-station use, attain excellent horizontal pattern circularity.

Since these antennas are mounted around the outside of the tower, they do not have the tower as a reflector in the immediate field of the antenna, which is a problem with side-mounted antennas.

The antenna shown is the BFF, a very high power 20 MHz bandwidth radiator. A pressurized radome is furnished.

RCA offers custom designing of panel antenna systems to suit the needs of individual users.

Circle 116 on Reader Service Card





# For Non-Technical Managers: How To Give Your Program Format Technical Support

By Irwin H. Fust Jr.

Without the right technical support, a program format may fail to make its effect, no matter how exciting it may be. Frequently smaller stations fail to get the most out of their facilities. The following is a primer on signal processing for program managers and other non-technical station executives. Learn the basics of making your sound attractive to the listener.

PROGRAM MANAGERS are all too likely to spend a lot of time working up a program format that will be especially appealing to listeners and a big help to the sales staff, while giving little or no thought to the technical factors that determine how the station *sounds* in the listener's living room. Technical considerations may not make a program format successful, but it can break one. With a basic understanding of AM modulation and of signal processing, the manager can make use of powerful tools for assuring the appeal of the station's sound. The following is a step-by-step exposition of this topic for managerial personnel.

## The basic waveform

Let us review the basics of AM modulation. Referring to Fig. 1 we see first the unmodulated carrier and then the carrier with 50% and 100% modulation. A receiver that is within range of a high power station will usually get a good, strong RF signal. But that will not necessarily insure that the audio signal riding on the carrier will also be strong and of the right quality to project effectively the station's program style.

Fig. 1 shows that the audio power available at the detector of the receiver is greater when the carrier is modulated 100% than when it is modulated 50%; in fact, it is four times greater. Obviously then, a station gains by maintaining its modulation as close to 100% as is possible. But, the normal program material that is broadcast is a highly complex waveform, which can't be kept at a high modulation level with-

out danger of some overmodulation—and an FCC citation. Thus audio processing is necessary. The processing used must take into consideration the type of programming with which we are dealing so as to determine what can be successfully done to improve its characteristics. The main forms of processing concern the dynamic range of the program material, range of frequencies to be transmitted, and the selective equalization of certain frequencies. These operations are used in varying degrees to increase the apparent loudness of the modulated signal, without an objectionable change in the "sound" of the program material. Let us look at each one of them separately.

## You need adequate dynamic range

Dynamic range is the difference, in decibels, between the lowest power level and the highest power level to be found in a particular piece of program material. Classical music, for example, has a large dynamic range, because of the great difference between the softest and loudest passages. Modern rock music, on the other hand, has very little; it's loud all the way. It may be desirable to allow music to be broadcast with small limitations of dynamic range, but for most material some processing is in order. This processing takes two forms which together provide a higher average percentage of modulation without serious distortion of the program material: automatic gain control and audio compression.

## Automatic gain control boosts selected frequencies

There are many types of automatic gain control amplifiers, (AGC) on the market, each one with its own list of claims of what it can do for your signal but, basically, they all operate the same way. The signal fed into the front end is automatically an-

---

Mr. Fust has been a chief engineer at several radio stations. He currently heads his own company Zero-Impedance Systems, Redding, California.



alyzed, and the lower power levels are amplified more than the higher ones according to a predetermined difference set by the operator. The higher peak power levels are passed relatively unchanged (see Fig. 2A) thus higher and lower signals are brought closer together.

An additional feature of most AGC units is a

threshold control which will let the operator set the particular level at which the automatic gain control function of the unit will begin. This is a highly desirable feature in that the program material can be acted upon, but such minute power levels as background noises, tape hiss, record groove noises, and inherent equipment noises will not be given the "ex-

Fig. 1. Unmodulated and modulated carrier envelopes which can be viewed on an oscilloscope. Fig. 2. Two methods for reducing the dynamic range of a complex audio signal.

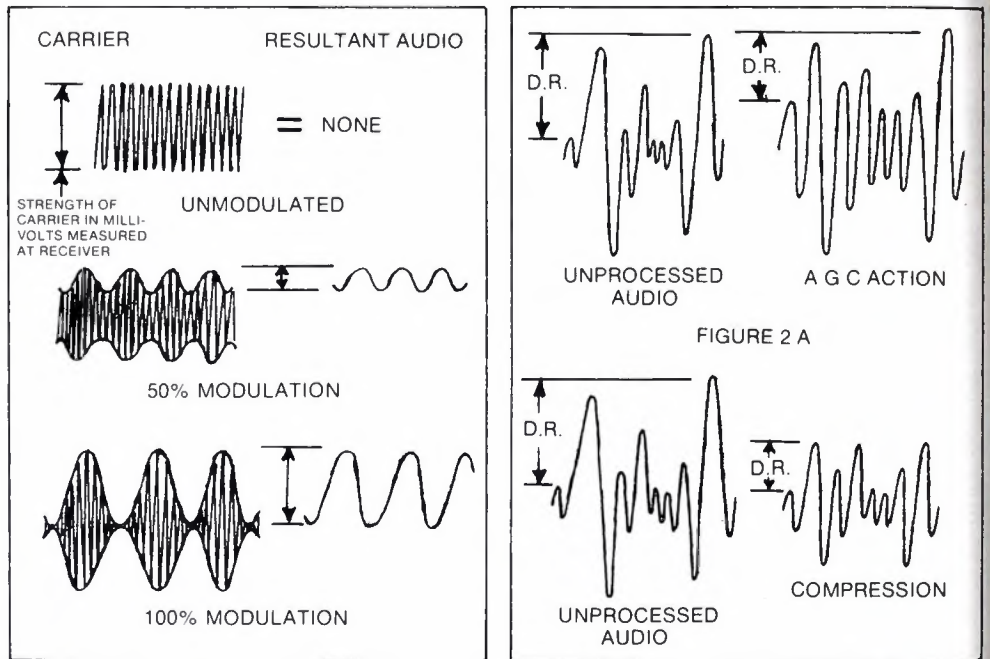

Fig. 3. The difference in the response curves for the two basic types of active equalizers showing a boost of 2 dB at 300 Hz and 5 KHz.

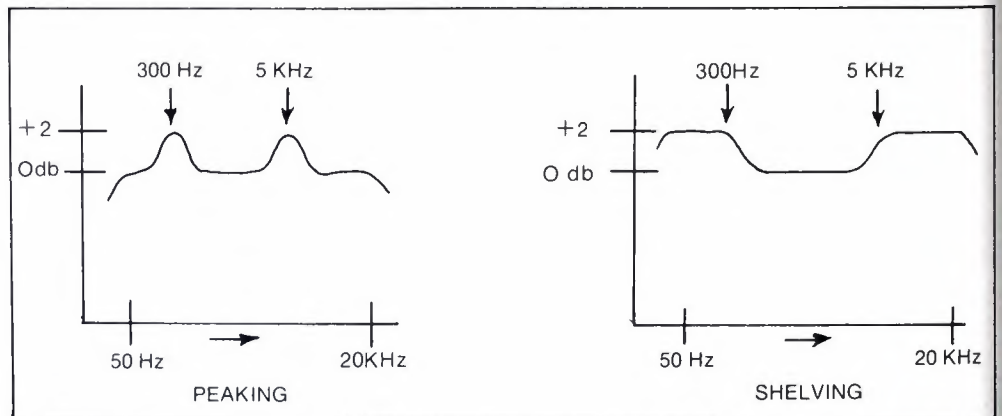
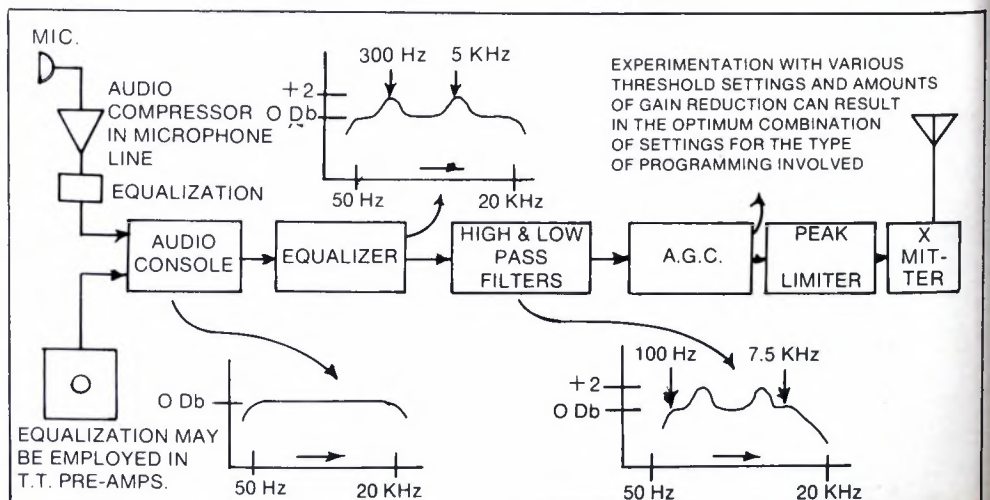

Fig. 4. Simplified block diagram of a typical audio signal hookup employing various methods of signal processing.





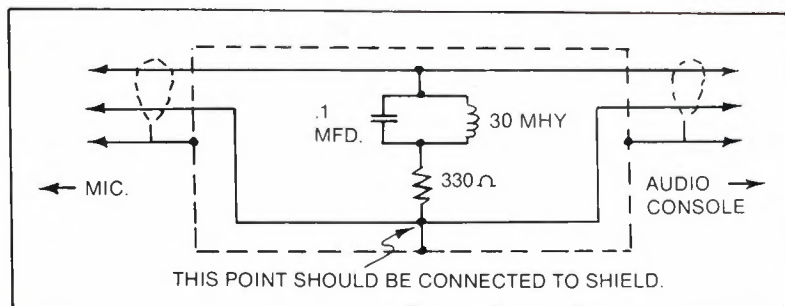

Fig. 5. A simple, inexpensive equalizer which can be inserted between the microphone and main audio console. This equalizer will produce a peaking boost of approximately 5 dB at 3KHz.

tra" amplifying action. This has the very positive effect of reducing the strength of the noise in relation to the signal: that is, of increasing the signal-to-noise ratio.

### Audio compression keeps you out of trouble

Audio compressors, on the other hand, decrease the dynamic range of the program material by reducing the levels of the higher peaks in the waveform (Fig. 2B); that is, by holding down the top rather than raising the bottom. This is a relatively easy and inexpensive way of reducing dynamic range. But there are several disadvantages to this method, foremost of which is a reduced signal-to-noise ratio which can be objectionable to the listener.

As a general rule, audio compressors are placed in the microphone lines before they enter the main audio mixing console. The human voice has the undesirable characteristic, for AM stations that is, of producing very large and unsymmetrical peaks which can easily overmodulate an AM carrier. The audio compressor can smooth out these peaks, allowing an increase in the average power level of the announcer's voice so that it will better match the power levels of the recorded music that, in most cases, surrounds it.

Using a combination of AGC and compression will, in general, allow the operator to increase the "average" percentage of modulation of the AM carrier on all program material which will have the effect of increasing the apparent loudness of the program material at the receiver.

### Super modulation

While it is against FCC rules and regulations to modulate a carrier in excess of 100% on negative peaks, positive peak modulation can legally exceed the 100% mark up to 125% as long as the distortion does not exceed specified FCC limits of 7.5%, carrier shift does not stray beyond 5%, and co-channel or adjacent channel interference stays below limits set by the FCC. With the employment of an asymmetrical peak limiter and some careful adjusting of program levels throughout the station audio system, positive peak modulation can be increased markedly, thereby giving the station another boost in program loudness at the receiver.

One must not exceed 125 according to a new FCC ruling made in April of this year. Supermodu-

lation could cause serious trouble if one does not have reliable processing equipment.

### A broad frequency range helps

Most audio equipment manufactured today has the capability of passing all frequencies from 10Hz to 20 KHz with equal amplitude and with an almost non-existent degree of distortion. Modern AM broadcast transmitters, while not being able to equal those specifications, can nevertheless come close enough to warrant being considered high fidelity equipment.

The average broadcast receiver, on the other hand, is altogether another story. It is not uncommon for a receiver to begin rolling off, rather rapidly, all frequencies beyond 5KHz, in an attempt to improve selectivity and reduce strength of atmospheric noises.

This means that while a broadcast station has the capability of generating an audio signal of high quality, it is doubtful that the listener at home will derive the full benefit of that quality once the signal has gone through his receiver. If a broadcast station concentrates some of its modulation capabilities on frequencies that can't be reproduced in full measure by the receiver, then that much of the total audio power is being wasted.

A better way of getting the most out of the transmitted signal would be to restrict the frequency response at the transmitter, thereby concentrating all available modulation capabilities on a band of frequencies the receiver will be able to reproduce well.

This method of increasing the apparent loudness of the audio signal can't be used too heavily though. Many of the higher frequencies that exist in a particular type of program material contain the overtones which give the material its distinctive and high fidelity quality. To limit these severely would do irreparable damage to the "sound" the station is trying to convey, producing a rather dead, flat, almost mechanical sounding signal. As a general rule, broadcasting a full range of frequencies between 100 Hz and 7.5KHz, with moderately sharp roll-offs at either end of this spectrum, will produce a signal which will be of sufficient quality and high total audio power when received.

### Selective equalization is tricky

Of the three methods of increasing the modulation efficiency of an AM transmitter, equalization is the

continued on page 58



# Solve The Cart Phase Problem With "Instant Alignment"

By Grady Moates

BY NOW, NEARLY EVERYONE in the technical end of broadcasting has at least heard about inter-channel phase error in stereo tape cartridges, and many of us have had lots of headaches trying to minimize its unwanted side effects of partial program cancellation in the mono mix, and poor frequency response.

The solution to the problem is beginning to come along in some new, better-made carts, but a lot of stations won't be replacing all their carts right away—that's a tremendous expense. They need a simple,

**Mr. Moates** is chief engineer of radio station WKOR, Starkville, Mississippi.

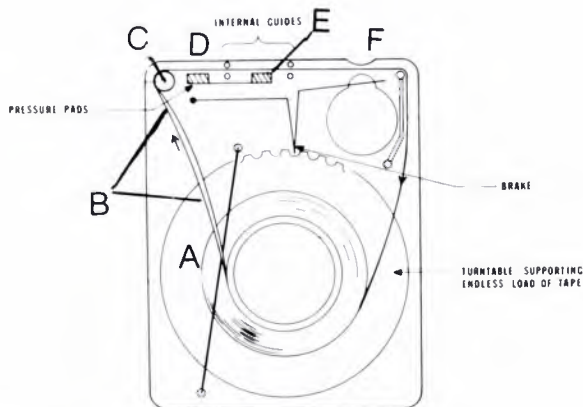

Fig. 1. Drawing of standard NAB cart

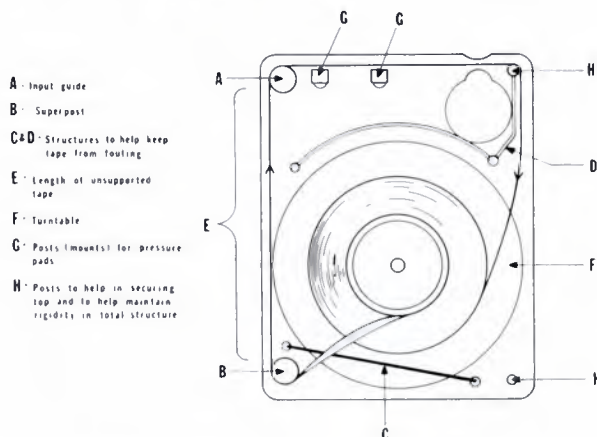

Fig. 2. Drawing of I G M Aristocart

inexpensive way to minimize the problem now—and here it is:

To understand it study first Fig. 1, an idealized drawing of the standard NAB tape cartridge:

- A) Tape pack
- B) Two twists the tape makes out of the ideal plane of travel
- C) Corner guide post
- D) Record head position
- E) Playback position
- F) Capstan position

A quick comparison of this cartridge tape system with its ancestor, the reel-to-reel system, shows several weaknesses in the cart design. Chief among them is the fact that the corner guide post, "C," must perform three functions: it must *straighten* the tape out after its travel out of the optimum plane, *standardize tension* of the tape across the heads to eliminate flutter and tape skew due to an uneven tape tension on each side of the capstan, and it must *guide* the tape over the record head's face, at the proper height above the deck plate, to standardize tracking and azimuth adjustments.

If you have had a few years' experience with the common broadcast cartridge, you know that it does none of these things well. In the old model Fidelipacs, for instance, corner post "C" is secured in a small hole with glue. After several months of handling, this post invariably begins to slide up out of its proper position, thereby guiding the tape into the head area higher than intended. The old Audiopak cartridge actually guides the tape with the plastic top of the cartridge. If that is warped, or the top screw is loose, you get a larger variation in tape height with the Audiopak than with the Fidelipac.

Before we go any further, it should be made clear that this is not faulty design work on the part of the cartridge manufacturers, it's our fault!! Manufacturers of tape cartridges, and any equipment or product in the world for that matter, are in the business of supplying us with what we want. When the original design for these carts was drawn, nobody said "phase error lower than 30°." And when we discovered the problem, we took years communicating it in detail to the manufacturers. So that's why the

continued on page 26



A built-in instant-alignment circuit is a very inexpensive way to reduce stereo cart phase error, while you gradually replace your old carts with the new, more precise models.

### The New Audiopak Cart Design

The IGM Aristocart cartridge described in the accompanying Moates article relies on accurate molding of tape guides rather than an adjustable guide. IGM says contrary to general opinion plastic mold accuracies of  $\pm .001$  inches can be maintained. Another company to take a similar tack is Audio Devices, Inc. Robert L. Manierre described the Audio Devices approach at the recent AES Convention.

Manierre says the NAB cartridge standard calling for .562 in.  $\pm .002$  in. for the upper left tape guide is not easy to maintain if one guide is in the cover and another in the base-plate. Typical molding tolerances of .002 in. for both cover and base adds to .004 in. Warp, poor fit, nicks and dents could increase this.

Inserting a guide by press fit into the base alone avoids the cover warp problem but there are still two pieces to create an out-of-tolerance situation. Cemented inserts can be adjusted to meet tolerances, but they are subject to assembly errors and adhesive failure. Drawing from experience in producing automobile 8-track carts, Audio Devices



Completed Audiopak cartridge.

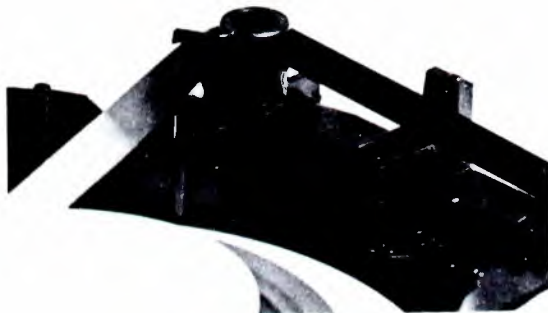

Note angled surface prior to corner post.

claims the entire guide can be molded as part of the base to  $\pm .001$  in. if the guide surfaces are formed by solid steel in the mold. It has adopted this approach in its new cart.

In most carts, guides are positioned after the corner post to push the tape down to the correct height for heads (usually tape climbs up the guide post). Audio Devices has introduced its precision guide prior to the corner post and incorporates an angled surface calculated to position the tape to the correct height by the time it reaches the corner post. Furthermore this guide bears on the entire surface of the tape and not just the top edge (which causes edge wear).

The Audiopak A-2 design has a few other innovations. A lower right hand corner post is used to prevent the loose tape problem and the hub brake has been eliminated. Brakes really do not hold tape—only hubs. Since the objective is to hold the tape for accurate cueing, Audio Devices does this by clamping the loose tape against the sidewall of the cartridge. For more information, circle 425.



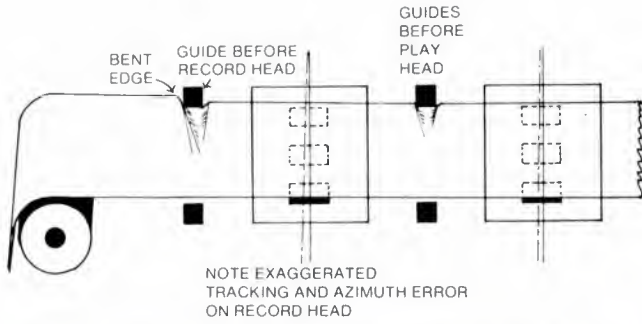

Fig. 3. When tape edge is bent, azimuth errors occur.

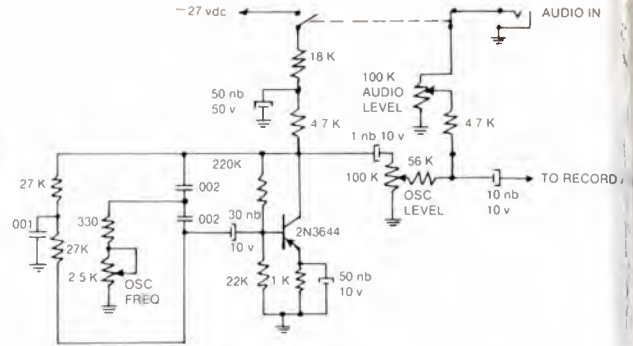
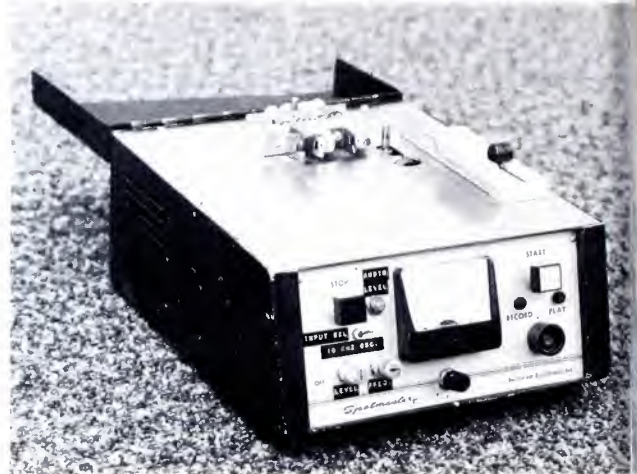

Fig. 4. Schematic diagram of twin-T oscillator.



Fig. 5. Modified Spotmaster 500C, with parts added labeled.



- A—Level (osc.)
- B—Frequency (osc.)
- C—Audio level
- D—Oscillator sw.

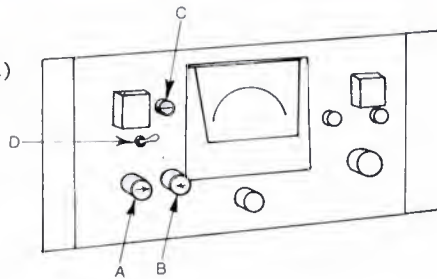

solution is just beginning to appear commercially. Now every manufacturer has a version to beat the problem. (Editor's note: Audio Devices is the latest; see box.)

Nearly all early designs of tape cartridges have problems with tape guide "C." Thus the biggest improvement the new designs have come up with is the adjustable guide or, in the case of the IGM Aristocart, (Fig. 2), another guide added at the rear of the cart which isolates the out-of-plane tape travel from the front guide. It makes the front guide and the entire front of the cart, for that matter, rigid and accurately positioned to optimize tape height and azimuth without individual cartridge adjustment. A welcome side-effect of this added post is a length of free-running tape between the tape turntable and the heads which acts to minimize fluctuation in tape tension, thereby cutting flutter and tension-associated tape skew to a minimum.

Another aspect of the guidance problem is that addition of a machine-mounted guide between guide post "C" and the record head at "D" is generally ineffective. Reason? The tape has just made a 120° bend around tape guide "C." This fact, coupled with the high tape tension normally encountered in a tape cartridge, means that the position of the tape as it comes off guide "C" is very "firm." Another guide in a different position vertically, located between guide "C" and the record head, usually just bends the edge of the tape that is out of line, rather than guiding the whole tape longitudinally down the face of the record head, Fig. 3. Occasionally a slack tape loop will allow an additional guide to perform its function properly but the lack of proper tension causes even worse problems—response and phase error that constantly vary because of tape skew!

Examination of the above would lead you to believe that most of the problem lies in the record part



of the system, rather than in the playback portion. Experiment verifies this hypothesis: simply record on a reel-to-reel machine a ten-minute length of tape with a 10 kHz tone, and then wind sections of it onto several carts. You will find very little phase error on the carts after you align the playback head to match the first cart.

It is easy to see why this is so; the tape guide before the playback head simply cannot overcome misalignment which is encountered before the record head. Therefore the tape is moved into the proper path *after* it has passed the record head.

Some new carts, of course, solve this problem, but the new carts, as already noted, cost money. Now if you could solve the problem inexpensively, even if it meant adding a little extra routine to your production work, you could slowly phase out the old carts, buying 50 or so new ones a month. Wouldn't that be nice?

You can. Since phase error is a direct product of improper azimuth alignment in recording, you can compensate for the improper entry angle on the record head by re-aligning the head each time you record a cart!

"Good grief!!," you say, "that would take hours to set up!" Not for the operator, if you took all the work out of it for him with a small built-in 10-kHz oscillator, with level and frequency controls, and an In/Out switch. It takes about an hour to build up, out of junk-box parts, another hour to install, and another hour to teach the operator how to use it. Then it takes between 15 and 30 seconds additionally every time a cart is recorded. It's worth it for many small stations who want quality sound, but don't have network-sized pocketbooks. Figure the cost of the proposed solution at a maximum of \$15 for new parts.

Fig. 4 is a diagram for a simple, twin-T oscillator, using any audio transistor with sufficient gain to oscillate in a circuit. The first one you pick up will probably work, biased properly. Don't worry about the low price tag. The only reason an H-P or B&K oscillator costs so much is the low distortion and stability. These factors don't matter in this application. The only drawback to this approach is the change in tracking. Within the limits of guide tolerances, this tracking error makes little or no difference. On a few carts, the noise level may rise a few dB, but that's better than losing half of your mono signal!!

The oscillator can be built on a small seven-terminal bakelite strip, and installed wherever there is free space. Current requirements for a small transistor in this type of service are so small that you can just resistively drop from even a tube plate voltage supply to the 20 or 30 volts you need.

I show a pnp transistor type in the schematic but, if you have only a positive supply available, just use an npn. The easiest way to switch from program input to oscillator is with a dpst two-circuit toggle switch. Use one set of spst contacts to disconnect the program input, and the other to apply voltage to the oscillator circuit. In this manner, the oscillator is switched off when the program input is being used.

which is a good idea, as 10 kHz will bleed across a toggle switch like a duck swims across water. It's best to have the decoupling capacitor on the oscillator side of the switch, with a time constant (decoupling capacitor and supply dropping resistor) of less than a second. Otherwise it will take a few seconds for the oscillator to reach full level.

Installation is simple. Align the playback head on the recorder as nearly perfectly as you can. Dope the adjustments, or tighten the lock screw if your head mount is so equipped. Align all *cart machine* playback heads in the station to this standard. Then, install a long bolt in the adjustment hole for record-head azimuth, to which you attach some kind of makeshift shaft that a knob will fit on. I used the bolt out of a core from a tunable coil, a nut that fit it, and a small round terminal with the terminal broken off which also matched the threads. If the top of the machine is not accessible when in operation, a 90° gear arrangement or a flexible shaft will allow you to bring the record azimuth adjustment out the front panel of the machine. Backlash isn't much of a problem, since you are simply adjusting for a peak response at 10 kHz. You just pass peak once, note the level, and then come back to that level.

Fig. 5 is a photograph of a Spotmaster 5000C modified in this manner, with (a) oscillator level, (b) oscillator frequency, (c) program input level (screwdriver adjustment), and (d) oscillator program switch.

Operation of the recorder as modified above is really easy. Don't erase the cart first. Simply select the cart you wish to use, insert it in the recorder, press the record button, flip the input switch to oscillator, and start the machine. While monitoring the machine's output on the board, adjust the azimuth knob for maximum indication on the production board's meter. If you're way off, you will notice several minor peaks on either side of the optimum position. Don't accidentally hit one of these. Normally, if you are that far off, you should check the corner guide post to see that it is firmly seated in its hole, or that the top isn't warped and is firmly screwed to the base of the cartridge. After adjusting for peak, stop the machine, flip the input switch back to program, erase the cart, and proceed as you would normally through the rest of the recording process.

It is interesting to note that this idea stemmed not from a phase problem, but from a frequency response problem that I was having at another station when dubbing a new jingle pack. I noticed a wide difference in the quality obtained with different carts, and set out to find a solution. Since correct azimuth means correct phasing (within 5 or 10 degrees) this cures that too. And a 30 degree error isn't that noticeable on the air, after all.

As a final note, let me emphasize again that this is an interim measure, designed to give the small budget radio station time to buy the new carts a few at a time, while not sacrificing quality until all carts have been replaced. New carts are the final answer to the phase error problem.

**BM/E**



# We've got Los Angeles SURROUNDED

Five Major Stereo Stations Have  
Switched to Jampro FM Antennas For  
Increased Clarity and Coverage:

## KKDJ-FM

Pacific & Southern Brdcastg.  
ERP 8,300 Watts  
ANTENNA: JAMPRO  
2 Bay PENETRATOR  
VSWR: 1.05 to 1  
HEIGHT: 2790 Ft. AAT  
TOWER: Mt. Wilson

## KPSA-FM

PSA Airlines  
ERP 34,000 Watts  
ANTENNA: JAMPRO  
8 Bay PENETRATOR  
VSWR: 1.06 to 1  
HEIGHT: 2783 Ft. AAT  
TOWER: Mt. Wilson

## KOST-FM

Mc Lendon Brdcastg. Co.  
ERP 12,500 Watts  
ANTENNA: JAMPRO  
3 Bay PENETRATOR  
VSWR: 1.04 to 1  
HEIGHT: 3100 Ft. AAT  
TOWER: Mt. Wilson

## KJOI

Able  
Communications  
ERP 75,000 Watts  
ANTENNA: JAMPRO  
4 Bay PENETRATOR  
VSWR: 1.07 to 1  
HEIGHT: 1180 F. AAT  
TOWER: Beverly Hills

## KXTZ-FM

Bonneville Brdcastg.  
ERP 105,000 Watts  
ANTENNA: JAMPRO  
6 Bay PENETRATOR  
VSWR: 1.07 to 1  
HEIGHT: 2890 Ft. AAT  
TOWER: Mt. Wilson



### The Jampro PENETRATOR FM Antenna

These Los Angeles FM stations have discovered how to cover 9.5 million people more effectively! They've switched to the JAMPRO PENETRATOR ANTENNA. With special engineering help, and computer aided design, these sta-

tions surround the Los Angeles market with solid signals, mile after mile. Get greater signal penetration, and better stereo separation with a Jampro FM antenna! Let Jampro engineers custom design your FM system.

## Let us surround your market too!

J  
A  
M  
P  
R  
O

**ANTENNA  
COMPANY**

A DIVISION OF  
COMPUTER EQUIPMENT  
CORPORATION  
(916) 383-1177  
6939 POWER INN ROAD  
SACRAMENTO, CALIF.  
95828

# Some Points on Care and Design of FM Antenna Systems

By Lewis D. Wetzel

THE ANTENNA SYSTEM is often the part of the station's equipment which receives the least attention, even though it is left to weather everything Mother Nature can dream up. The initial cost of the antenna system is usually a quarter to half the cost of the transmitter which receives daily attention. Some simple guidelines may be useful in maintaining an existing antenna system or choosing a new one.

A key meter in the transmitter system which can give the operator some indication of how the antenna is performing is the reflectometer, or VSWR meter. Unfortunately, this measuring device is 1) often installed at the wrong place; 2) not designed to give the needed accuracy; or 3) not supplied with the transmitter.

Let's take a look at the reflectometer which should really be considered a part of the antenna system. It is a device which should be inserted into the transmission line after the harmonic filter. It should have a directivity of about 35 dB and a coupling factor which is proper for the associated meter. The reflected or reverse power probe should preferably have 6 to 10 dB more coupling, but this gain must be coordinated with the meter scale. The proper adjustment of these probes is made at the factory. No attempt to alter the adjustment in the field should be made unless fairly elaborate test equipment is available to assure knowledge of results.

Calibration of the reflectometer, however, is a function which the engineer must perform at the station whenever a proof-of-performance is made. To assure accuracy, the transmitter should be operated into a dummy load and the reflectometer adjusted to indicate the operating power level. By reversing the leads from the directional coupler and switching the reflectometer to the reflected position, the calibration in this position may be checked taking into consideration the reflected coupling factor.

## VSWR should be below 1.3

If the VSWR on your antenna system is above 1.3 under normal conditions, an effort should be made to determine the reason. Some of the things to check are: the accuracy of the reflectometer; the correct placement of the reflectometer in the system; uniform temperature along the transmission line; no presence of moisture in the system; good contact of all connectors; and proper antenna installation.

Let's take a look at some of these trouble indica-

tors in addition to the aforementioned problems concerning the reflectometer. A discontinuity will cause hot spots every half wavelength along the transmission line—until the reflected energy has been dissipated. It is, therefore, necessary to get within a few wavelengths of the trouble or the hot spots will not be apparent.

Moisture in the system is difficult to determine, so the easiest remedy is to purge the system periodically with dry air or dry nitrogen. Be sure the dehydrator is delivering dry air. For convenience in purging the system, an eight to ten pound pop-off valve can be installed in place of the bleeder plug on the antenna.

A periodic resistance measurement of the transmission system using a bridge is a good way to detect or anticipate connector problems in the transmission line. The value of this reading will, of course, depend upon the length of line in the system but it should be in the 50 to 500 milliohm region. If a high resistance reading is obtained, a time domain reflectometer or pulse measuring equipment can be used to locate the fault.

Refer to the installation instructions and drawings to assure yourself that the ground straps are in place and that the antenna radiating elements are intact. Falling ice and careless riggers can cause troublesome damage.

If the antenna transmission system does not hold pressure, find the leak. A system without pressure invites moisture to accumulate and the voltage breakdown point of the system decreases drastically. To check each element of the antenna, have your antenna man hold a 15-watt fluorescent tube at a similar position from each element to check for equal radiation. Bad connectors or mistuned elements within the antenna may be located in this manner.

## Use the right antenna size

When an antenna system is being designed for a new station, or an existing system is being replaced, several factors should govern the type and size of antenna and transmission line. Conservative ratings for a transmission line which allow for a rise in VSWR without damage to the line are as follows: 8 kw for 1½ in. line, 30 kw for 3¼ in. line, 60 kw for 4¾ in. line, and 120 kw for 6¼ in. line. Bear in mind that the ratings given in the catalogs are for unity VSWR with dry air in the line. Laboratory conditions are seldom met in the field.

How much gain should the antenna have? The FCC limits the Effective Radiated Power of FM

continued on page 56



# An Automated Measurement System For Vertical Interval Test Signals

By Stephen D. Kerman

SOMETIME TODAY an engineer in your television station will probably monitor an incoming network feed. He'll take a waveform photograph of the VIT signal and mail it to network headquarters. Network engineers studying your waveform picture and others, including round-robin photos, may determine that there were distortions in the transmissions. They may even be able to tell where they occurred.

Elsewhere, engineers at satellite ground stations around the world are looking at signals from communications satellites and, hopefully overcoming the language barrier, will communicate with their opposite numbers to correct transmission distortions.

Planners of Domestic Satellite Systems are anxious to have facilities for remote analysis of transmissions using the vertical interval test signals, but cannot afford to have men located at all remote ground stations.

*All of these people have a similar problem: remote on-line monitoring of a video waveform and the correction of distortions—quickly and automatically.*

In late 1971, Television Products engineers at Tektronix, Inc. started a project to solve this problem. In April 1972, the Tektronix ANSWER system was demonstrated to television industry leaders at the NAB Convention.

Before an automated testing system for television transmission distortions could be considered, stand-

ardization of three things had to occur. First, standard test signals had to be established. The composite test signals in use today by the broadcast and satellite transmission people, Fig. 1, fit this requirement.

Further, transmission parameters, the distortions to be measured, must be determined. Finally, measurement techniques must be standardized. An automated system would be less than effective if each link in the chain made measurements in a different way. These three requirements have been satisfied and work on systems has been underway in Europe and Japan.

The ubiquitous composite test signal which includes a modulated staircase, 2T sin squared pulse, a 12.5T modulated sin squared pulse, and a T rise bar enables the measurement of 18 transmission parameters. (See Table 1.)

In the U.S. today, two versions of the composite test signal are in wide use. Fig. 1a shows the test signal now required by the F.C.C. for remote operation of television transmitters. This signal occupies line 19 of both fields.

Figure 1b is the test signal #1 of the Satellite Technical Operating Committee and is in use on international satellite transmissions. It is usually inserted on line 17. There are only minor differences between these two signals and they may be attributed to the different applications in which they are used. You will see later that these two minor differences may be easily accommodated by programming of the ANSWER system.

The fundamental problem in attempting to telemeter the VIT signal waveform is video bandwidth. Relying heavily upon the expertise provided by the Tektronix sampling oscilloscope engineers, the television engineering people developed a VIT signal processor which reduces the required bandwidth of the telemetry channel by several orders of magnitude. The VIT signal is telemetered to a remote location on ordinary voice grade telephone lines.

The timing of the VIT processor is derived from the video signal itself. Voltage samples are taken at precise times in the television line. After processing, which is described below, the VIT waveform is reassembled at the remote location on a large screen storage display device.<sup>1</sup> Hard copies for permanent records are obtained using a 4601 hard copy unit.<sup>1</sup> (See Fig. 2.) The display location may be any distance from the sampling site. They are connected

<sup>1</sup>Manufactured by Tektronix, Inc.

**Mr. Kerman** is manager, TV Products Market Development, Tektronix, Inc.

Table 1: Video transmission parameters measured with composite VIT signals.

	<u>SIGNAL</u>	<u>REFERENCE</u>
SIGNAL LEVEL	BAR	BLANKING
1 SYNC LEVEL	SYNC	BLANKING
2 BURST LEVEL	BURST	286 mV
3 CHROMINANCE LUMINANCE GAIN	12.5 T	BAR
4 CHROMINANCE LUMINANCE DELAY	12.5 T	12.5 T LUM
5 DIFFERENTIAL GAIN	MOD STAIRCASE	286 mV
6 DIFFERENTIAL PHASE	MOD STAIRCASE	BURST
7 BURST STATIC PHASE ERROR	MOD STAIRCASE	0 FIRE CHROMA
8 LINE TIME NON-LINEARITY	MOD STAIRCASE	
9 PEAK WHITE CLIPPING	MOD STAIRCASE	
10 2T PULSE TO BAR AMPLITUDE	2 T	BAR
11 2T PULSE OVERSHOOT, PRESHOOT	2 T	714 mV
12 LINE-TIME LINEAR DISTORTION	BAR	714 mV
13 STEP TRANSIENT RESPONSE	BAR	
14 STEP-TRANSIENT SHORT TIME		
15 STEP-TRANSIENT LINE TIME		
16 BREEZEWAY DURATION	SYNC + BURST	
17 SYNC WIDTH	SYNC	





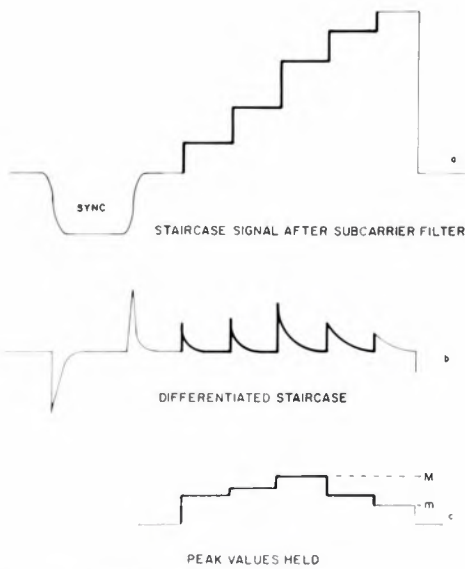

Fig. 6. Line-time non-linearity measurement per CCIR.

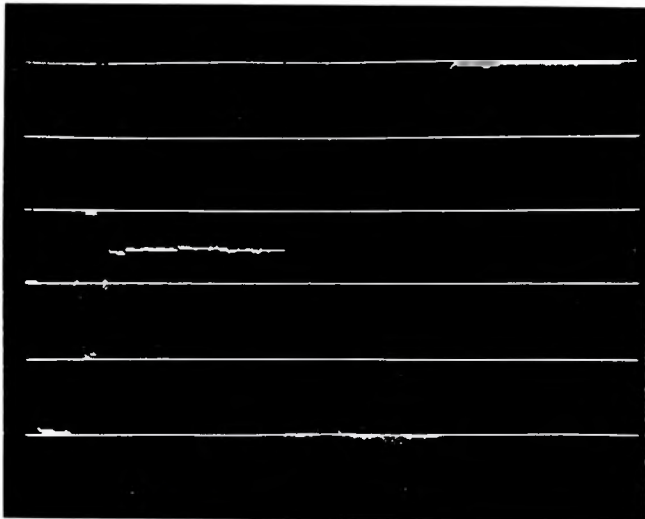

Fig. 8. ANSWERGRAPH of a reference test signal.

by conventional telephone circuits only during the sampling time and thus minimum long distance telephone charges are accrued.

The sampler of the VIT Processor takes a sample once per field or once per occurrence of the VIT Signal. The sampling time is approximately 20 ns. This sample of the analog voltage is converted to an 8-bit word in a D to A converter. With 8 bits, the amplitude resolution ( $1/2^8$  or  $1/256$  of full scale) is better than can be obtained reading a conventional oscilloscope. Further resolution would be unwarranted because of random noise in the signal and the bandwidth of voice grade telephone circuits.

The vertical interval line carrying the composite signal is divided into 1024 elements. Each element is transmitted at a  $1/30$  sec. rate. The total transmission time for the signal is  $1024/30$  or about 35 seconds.

A quick calculation reveals several inadequacies

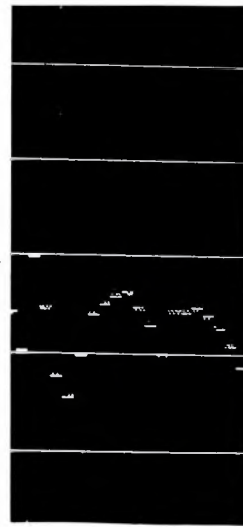

Fig. 7. Measurement results of non-linear distortions, i.e.,  $dY$ ,  $dG$  and  $d\phi$ . Signal averaging has eliminated noise on this portion of the display.

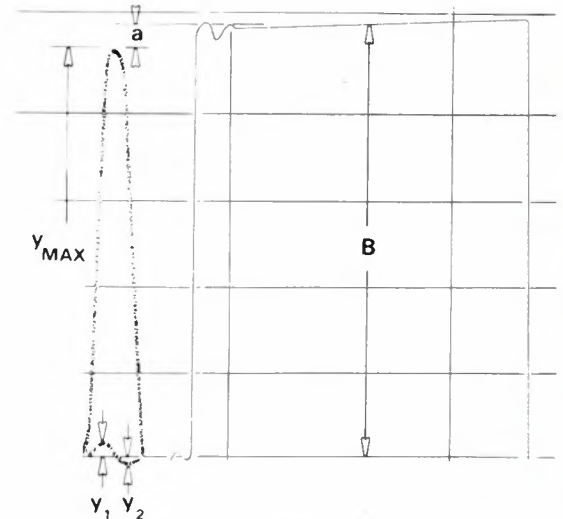

Fig. 9. 12.5T sine-squared pulse used to measure luminance-chrominance gain and delay irregularities.

in the time resolution of such a system as the 2T and T rise of the bar, as well as the sinusoidal cycles of the subcarrier cannot be resolved when the  $63.5\mu$  seconds of the television line is divided by 1024 elements.

The ANSWER VITS processor carries out additional steps to insure adequate resolution. The VITS sampler is programmed for two sampling rates. Where higher time resolution is required, samples are taken closer together. Fig. 3 shows a portion of the ANSWERGRAPH display. Note the resolution of the 2T and the rising portion of the bar. The portion of the trace not requiring the higher resolution is sampled at a lower rate. The effect is that of an automatically programmed horizontal magnifier, similar in function to manual magnifiers found on conventional oscilloscopes.

Because of the precise spacing of the samples, rise times may be computed by the simple expedient of counting the dots. The dot-to-dot spacing is

5 ns. Two speed sampling effectively handles the fast rising portions of the signal but is still ineffective in reproducing the subcarrier sinewave. Since the information of importance in the subcarrier is represented only by its amplitude and phase, there is really no reason to transmit the actual sinusoid. The Tektronix VIT Processor includes two detectors. After removing the luminance component, the chrominance is fed to both a phase and envelope detector. Color subcarrier is regenerated from program burst, using the same synchronous detector as is used to demodulate the staircase chrominance. The low frequency component recovered at the output of the detector is used to measure differential phase and static burst phase error. Differential phase (in accord with IEEE Standard 206 Method C) is the peak-to-peak variation of the phase of staircase subcarrier. It is not measured with respect to burst. Since the phase of burst may be altered by VTRs or processing amplifiers, the ANSWER system utilizes the first step of the staircase (4  $\mu$ sec at 10 IRE precisely in phase with burst) as a comparison with the detected value of burst phase. Any static burst phase is represented by a difference between the first step and burst. Differential phase, the peak-to-peak measurement, is also easily read and is seen in Fig. 4.

Differential gain is measured by envelope detection of the sub-carrier component of the staircase. Peak-to-peak measurements are used here too.

It should be noted that CCIR measurements differ considerably from the IEEE Standard. In fact, the CCIR recognizes that a 2:1 difference in readings may be found. An interesting facet of the ANSWER system is that either method may be used for measurement without altering the hardware. Only the measurement method changes which is handled in the software for the system.

Differential gain measurements describe the small signal non-linearities of the chrominance signal. It is sometimes assumed that the luminance signal distortion is similarly described. This is not necessarily true, especially in microwave radio relay systems. Non-linearity in amplitude response may be frequency dependent. The ANSWER system measures luminance non-linearity which the CCIR calls "line time non-linearity."

First, the chrominance is removed from the staircase by a low pass filter. The steps are differentiated so that the step risers appear as narrow pulses whose amplitudes are proportional to the riser amplitude.

The peak value of each pulse is fed to individual memory capacitors and the resultant display appears as in Fig. 5. The CCIR defines luminance non-linearity as  $(1-m/M)\%$ , Fig. 6.

Differential phase and gain measurements using vertical interval test signals have always been hampered by the masking effects of noise. In the display shown in Fig. 7, it is seen that there does not seem to be any noise. The ANSWER system performs post-detection signal averaging. The various capacitive memories do not charge to full value each time the signal occurs. Since the average value of noise is zero, successive measurement signal averaging tends

to eliminate the noise from the display. In fact, by this signal averaging technique, the noise bandwidth is reduced to 60 Hz. A noise power reduction of 40 dB is attained with no loss of measurement accuracy.

Since scale factors and levels are normalized by the VITS processor, a distortionless signal would present an ANSWERGRAPH display as shown in Fig. 8. A cursory glance at this flat line display is enough to note the absence of non-linear signal distortions.

It was shown earlier how, by the use of a dual sampling rate, the display of the 2T and T rise bar is attained. The 12.5T modulated sine squared pulse contains information of relative chrominance-to-luminance gain and delay. As has been shown,<sup>2</sup> this information is contained in the envelope of the pulse and not in the chrominance modulation itself. The ANSWER display of the 12.5T pulse is shown in Fig. 9.

You will see that this display, as well as the display of all linear distortions, looks very much like the waveform monitor display used today. Engineers familiar with distortion measurements adapt readily to the ANSWER display. Since the information is in digital form, however, it should not take a great deal of imagination to envision the addition of computer analysis and control.

An electronic graticule is generated in the VIT processor and passes through the entire system. This encoded reference acts as a self-calibration for the ANSWER system.

Two timely uses for an automatic signal processor, such as the ANSWER processor, come to mind.

Within the past year, the FCC has authorized the unattended operation of television transmitters. As part of this requirement, the composite test signal must be radiated as a VITS and monitored every 30 minutes. Any change in this or the color bar or multiburst signal must be logged.

The basis for this remote monitoring is a demodulator located at some distance from the transmitter. The ANSWER system would eliminate the need for remote off-the-air monitoring and would prevent the "Perils of the Radio Path" by processing the VIT Signal after demodulation at the transmitter. Using ordinary telephone lines, the digital ANSWER signal would be relayed to the station where it could be monitored or fed to a mini-computer for analysis and subsequent logging. The computer could be programmed to indicate performance limits, sound an alarm during out-of-spec performance, or automatically cause the change over from one transmitter to a stand-by.

Many industries depend on computers for process control, statistical analysis, and maintenance scheduling. Television stations and networks should be no exception.

For networks, surveillance is a particularly vexing problem, especially now that the carriage of television signals is being shared by miscellaneous mi-

<sup>2</sup>"The 12.5T Modulated Sine-Squared Pulse for NTSC" by Charles W. Rhodes, IEEE Transactions on Broadcasting, Vol. BC-18, No. 1, March 1972.

continued on page 62



# Too Many Stations Have Too Little Test Equipment

TV stations are fairly well-equipped, but many radio stations are relying on their engineer's ears.

DO YOU HAVE THE TEST EQUIPMENT to measure what's going on at your station? *BM/E* asked that question of a sampling of readers and got back some eyebrow-raising results. Would you believe no test equipment? That's the complement of one station; it relies on its chief engineer to supply the necessary test gear.

There are other disturbing facts. Only about one-half of the AM stations have a vacuum-tube voltmeter. Half do not have dB meters. One out of six does not have an oscilloscope. Stations that are FM or AM/FM are generally better equipped. Seventy percent have VTVMs; 80% have dB meters. Everyone has an oscilloscope and half of those are precision scopes. As might be expected, stations in larger markets are better equipped.

Just about every station has a precision audio oscillator, but a few do with a general purpose signal generator. The latter usually do not have the gear to calibrate it. Precision attenuators are relatively unknown to AM stations. So are true RMS voltmeters (but one-third of FM stations have

them). A fairly universal piece of equipment is a harmonic distortion meter. On the other hand, intermodulation distortion analyzers and wow and flutter meters are rare instruments. Very few AM stations have any kind of frequency or timing standards. About one-third of the FM stations do—but those who don't do not feel the need to change.

Impedance bridges that can be operated in the antenna circuit are owned by only about 20% of the radio stations reporting, but is one piece of equipment that most (over half) engineers would like to buy.

What else is sought by radio engineers? Those who don't have harmonic distortion analyzers want them. Those engineers who already have well-equipped stations opt for frequency counters, digital electronic voltmeters, logging equipment, and RF wattmeters. Those with FM stations would like to own spectrum analyzers. Sweep generators are used by a few FM engineers and a few others would like them.

It appears that engineers are fairly well satisfied with their RF monitoring equipment, although FMers apparently would like to get better FM frequency monitoring equipment. At least one engineer wants to purchase a number of AM-FM receivers so that his personnel could monitor the station's signal at home and in the office.

## TV engineers better off

TV stations are certainly better equipped than radio stations. There is more audio instrumentation at hand, as well as video test equipment.

On the audio side, for instance, every TV station has precision audio oscillators and most have precision oscilloscopes—and they use Polaroid scope cameras. Fully two-thirds have frequency counters. The remaining one-third would like to buy them. Most have electronic voltmeters. One-third have digital versions. Another third would like to buy digitals.

Use of audio square wave or tone burst generators is a common practice in TV stations; such use is a rarity in radio stations.

While only one in six has a spectrum analyzer, a quarter of those who do not would like to buy such an instrument. TV station engineers are also more interested in audio intermodulation analyzers and wow and flutter meters than their radio counterparts.

In the video area, everyone has some kind of video test generator and waveform monitor. Two-

## Audio Instruments—They Get Better and Better

The following were among the more interesting of the many test instruments on display at the AES show:

**Bruel and Kjaer:** A "reverberation processor," Type 4422, gives a direct reading of the early reverb decay time, using the Schroeder integrated-burst method which minimizes irregularities.

**Crown International:** A new intermodulation distortion analyzer, Model IMA, approaches a residual of 0.005% on typical readings, with two meters, one for fast calibration, with ranges starting at 0.1% full scale, a "tracking attenuator" for IM plots over a 45 dB range and other convenience features.

**Elpa Marketing:** Ferrograph RTS-1 Recorder Test Set combines in one unit measurements of wow and flutter, frequency response, noise ratio, gain, distortion, crosstalk erasure, output power and drift, for pro tape machines.

**Systron-Donner:** A new spectrum analyzer of outstanding versatility and accuracy; range is 10 Hz to 50 kHz, will show whole curve or any selected part in log or linear coordinates; and with selected vertical scale; frequency can be read to 1%, with resolution to 10 Hz; parts or whole of curve can be stored for several hours as a standard or reference, with a second trace for later real-time events.

**TASCAM (TEAC):** An excellent flutter meter; can be set for NAB or ANSI weighting; frequency is read digitally, percent flutter on meter, includes a 0.1% full-scale range.

thirds have a VIT generator. There is keen interest in purchasing other pieces of equipment—either as new items or for replacement purposes. Over 35% would like gain and delay test sets (less than 25% have them); over 25% would like chrominance/luminance gain normalizers (half have them now); over 25% want oscilloscope camera attachments. One engineer out of five is interested in a new demodulator.

Other equipment of interest to 10% (or more) of TV engineers responding to *BM/E*'s survey: video test generators, color bar generators, pulse and bar generators, color picture monitors, monitor comparators, VIT generators, remote control VIT equipment, non-linear distortion analyzers, video noise meters, and VSWR meters.

**Some recent new equipment**

There are many specialized pieces of equipment available to the broadcaster and some that are general purpose, but nonetheless useful. Those recently announced are summarized here.

**Combination color phase equalizer and waveform corrector marketed**

A new system of TV transmitter color phase and waveform corrections, incorporated in the Datatek D-701 series, combines frequency domain correction with time domain correction for versatile distortion elimination. A fixed-characteristic delay corrector introduces both the low and the high-frequency action needed by the "average" transmitter with a smooth curve sideband response. The waveform corrector then provides continuously variable delay and amplitude correction as may be required by the specific transmitter. The units has 75 ohm input,  $\pm 6$  dB of gain, knob selectable, takes in 0.5 to 2.00 volts p-p composite video and puts out 1.0 v p-p composite video. The waveform corrector provides six leading echoes and 12 trailing echoes at 120 ns intervals, front panel adjustable positive or negative from 0 to 30 IRE units. Trailing axis has three first-order sections, front panel adjustable positive or negative from 0 to 40 IRE units, and front panel time-selectable with values between 100 and 6800 nanoseconds.

Some 20 stations are currently using the equipment made by the Union, N.J. company.

**High-speed signal peak indicator uses flashing lights**

Something new in amplitude modulation monitoring gear was introduced last spring as an outgrowth of an industry-FCC study. The Model FM-103 Flashmeter is a peak-signal indicator using a row of horizontal lamps, which are lighted in sequence to indicate modulation peaks. The lamps cover the range from 0 to 140% in increments of 10%. Lamp on-time for a single pulse is about 165 ms, to assure viewer response. There are separate positive and negative peak calibration controls. The unit is used with an AM, FM, or TV aural modulation monitor, and covers the band from dc to 100 KHz. Manufacturer: McBee Laboratories, 5151 Wisconsin Avenue, N.W., Washington, D.C.

**Test Equipment at TV Stations**

	Range Reported		
	Min.	Avg.	Max.
Video test generator	1*	1	3
Color bar generators	1	3	6
Pulse and bar generators	1	2	3
Waveform monitors	2	10	16
Picture monitors, mono	5	20	43
Picture monitors, color	2	8	12
VIT test generators	0	1	2
Remote control VIT test set	0	0	1
Gain and delay test sets	0	0	1
Video sweep generators	1*	1	1
Oscilloscopes	2	4	10
Oscilloscope cameras	0	1	2
Monitor comparators	0	0	1
Nonlinear distortion analyzer	0	0	1
Video noise meters	0	0	1
Demodulators	1	1	2
Sideband analyzers	0	1	2
Chrominance/luminance gain normalizers	0	1	1
Time and frequency meters	0	1	1
VSWR meters	0	2	5
Power meters	1*	2	4

\* A few stations report none

**Test Equipment at Typical Radio Stations**

	Poorly	Well
	Equipped	Equipped*
VTVM, analog	0	2
VTVM, digital	0	0
True RMS voltmeter	0	1
Gen'l purpose signal generator	0	3
Precision audio oscillator	1	3
Square wave & tone burst gen.	0	0
Precision attenuators	0	0
Gen'l purpose oscilloscope	1	2
Precision oscilloscope	0	1
Sweep generator	0	1
Spectrum analyzer	0	1
Harmonic distortion meter	1	3
Intermodulation meter	0	0
Wow and flutter meter	0	0
dB meter	1	**
Frequency counter	0	1
Phase meters	0	2
Operating impedance bridge	0	2
RF wattmeter	0	4
Field intensity meter	0	1

\* These figures represent two specific stations. *BM/E* found no one station having all of the above equipment although each piece is in use at one or another station.  
\*\* "Many" reported.

**Audio sine generator is designed for proof-of-performance testing**

An audio sine-wave generator, the F380A, has been introduced by AILTECH, (formerly Microdot) of the City of Industry, Calif., with characteristics intended to make the instrument applicable to proof-of-performance or other high-precision testing. Frequency range is 20Hz to 20 KHz, total distortion less than 0.1%, hum is 100 dB below zero. Output impedance is selectable 150/600 ohms balanced, output attenuation is calibrated over a range of 110 dB, and a built-in output voltmeter is calibrated in volts and decibels.

continued on page 38



# Shibaden video cameras...

# show it like it is



Indoors or out. Shibaden broadcast-quality color-TV cameras "see" what the eye sees. They capture all the true color, all the sharpness, all the fidelity.

Take the Shibaden FPC-1000A, pictured above. This stable, simple-to-operate color camera combines top performance with top value. Its three vidicons provide superior sensitivity. It meets critical performance standards and offers all the features you expect in a quality broadcast camera (and more than you'd expect at one at this price!).

Other Shibaden color cameras about which you may want to learn more are, left-to-right, below: FPC-1000H. Broadcast version of the 1000A with additional features, including a built-in I and Q encoder. The HV-1100 is ideal

for video-microscopy and fiber-optic interface, and is lightweight (17½ lbs.). Then comes the excellent, top-performing Shibaden FP-1200 three-tube Plumbicon\* studio camera. It obsoletes others in its class.

Add monochrome cameras, color and monochrome VTRs, monitors, lenses, and the rest of the 150-product Shibaden line . . . you'll begin to see why we think Shibaden will do wonders for your image.

#### **SHIBADEN CORPORATION OF AMERICA**

Exec. Off. 58-25 Brooklyn-Queens Exp'y, Woodside, N.Y. 11377  
21015-21023 S Figueroa St., Carson, Calif. 90745  
1725 No. 33rd Ave., Melrose Park, Ill. 60160  
100 Martin Ross Ave., Downsview, Ontario, Canada



# Shibaden video recorders...

# show it like it was



Shibaden TV Playback

In full, clear color or sharp black and white Shibaden professional video tape recorders record and play back all the fine detail that the camera catches.

All Shibaden VTRs feature Servo Capstan design. In play back mode tape speed is independent of head speed. The result is a perfect uniformity that makes every tape look "live". Simply tune down capstan speed for variable slow motion and stop action. Servo Capstan, Slow/Stop motion and Internal Sync are just a few of the many features you'll find in Shibaden 1/2" VTR's. And all included as standard in surprising moderate prices.

Shibaden "D" series VTRs — such as the SV-520D color unit (above), and the SV-510D recorder (2nd from left, below) — feature

specially designed electronic insert and assembly editing. In their price range, you won't find a more stable system.

All Shibaden VTRs meet EIAJ and EIAJ recommended standards and interchange with other recorders conforming to the same EIAJ format.

VTRs are just part of the 150-product Shibaden line. Monochrome and color cameras, monitors, lenses, and all accessories fill out a really complete professional line. That's why we say Shibaden will do wonders for your image.

#### **SHIBADEN CORPORATION OF AMERICA**

Exec. Off. 58-25 Broadway, Queens, N.Y. 11377  
21015 21093 S. Francisco St., Los Angeles, Calif. 90044  
1725 Hs. 33rd Ave., Montreal, P.Q. H3M 1S1  
100 Martin Road, Ave. D, Westmount, Quebec H3T 1G1



Circle 117 on Reader Service Card



## Paper On Antenna Monitoring Instruments

Techniques used in the latest generation of antenna monitoring instruments, which often have more precise and stable operation than those of five to seven years back and at lower cost, are described in a detailed but little-noticed paper presented several years ago by William Holton Casson, president of Potomac Instruments, Inc. Mr. Casson describes the basic circuits for digital phase measurement, limiters to eliminate phase jitter, loop current detectors and other related instrumentation. The paper also describes the use of the antenna monitoring equipment, especially the new high-precision equipment needed for critical antenna arrays, including specifically some models of Potomac Instruments. Copies of the paper are available from Potomac Instruments, Inc. at Silver Spring, Md.

## Impedance Bridge Checks Antennas in Operation, Without Detuning

Another aspect of antenna measurement is represented by the OIB-1 operating impedance bridge, developed by Delta Electronics Inc., 5534 Port Royal Road, Springfield, Va. The bridge accurately measures the impedance of most antenna elements with full power applied, since it will handle

up to 5 kw of through power and does not detune the antenna element to which it is connected. The insertion effect is equal to only 9 in. of 150-ohm line. The null circuit has sensitivity adjustment, and a selectable tuned circuit for increasing sensitivity; a connector allows use of an external null detector. The instrument will measure negative impedance, show matching of adjusting networks to line, measure common point impedance, locate power loss, make SWR measurements, and do a number of other checks on antenna systems. A paper on the subject is available.

## Other Literature

Most test equipment manufacturers have application notes that contain helpful information. That available from Tektronix and Rohde & Schwarz is probably best known to **BM/E** readers since such items have been offered in our New Literature section. The Wiltron Company, 930 East Meadow Drive, Palo Alto, Calif. 94303, has several technical reviews of interest: "Broadband SWR Measurements" (Vol. 1, No. 1) and "Audio-Video Phase Meter" (Vol. 2, No. 1). Marconi has a handbook on TV transmission measurements which it will send to those who write to them at 11 Cedar Lane, Englewood, N. J. 07631.

## NEW INSTRUMENTS

**Nine-digit frequency counter** measures from 5 Hz to 512 MHz, with a sensitivity of 10 mV rms at 500 MHz. Model 5700A counts directly to 220 MHz and pre-scales only by two from there to 512 MHz. Optional frequency offset capability allows displayed frequency to be offset a fixed amount from the measured frequency. Frequency standard is a 10 MHz crystal with aging rate less than 2 parts per 10<sup>9</sup> per day. \$895. Higher stability option, 1/10<sup>7</sup> day, for \$195 extra. **BALLANTINE LABORATORIES. 400**

**Field strength meter** covers 40-260 MHz and 470-890 MHz. Mark I operates on four 9-volt batteries, has single-knob tuning with indications in both dBmV and microvolts. Input connection is 75 ohms, and weight is 7 pounds. \$389.00. **AMECO INC. 402**

**Portable electronic counter** can run on ac, on any 11 to 30 volt dc source, or on self-contained rechargeable battery pack. The 5300 Series measures up to 525 MHz, with sensitivity 25 mV to 80 MHz, 100 mV to 500 MHz. Intended for measurement of mobile communications equipment, the 5300 will meet FCC measurement standards when equipped with optional temperature-compensated crystal oscillator, \$1195; high-stability crystal option, \$175. **HEWLETT-PACKARD. 403**

**RF interference locator** tunes from 540 KHz to 220 MHz in six bands, covering AM and FM radio and VHF TV. Model 610 has 2 microvolt or better sensitivity. It operates on internal batteries or on optional ac power adaptor. **SPRAGUE. 404**

**Digital voltmeter** has three-digit resolution plus an over-range digit. Model PM2422 covers five ac and dc voltage ranges, and six ranges of resistance. Accuracy is 0.2% + 2 digits over most of the bandwidth of 30 Hz to 30 kHz. \$395. **PHILIPS (TEST AND MEASURING INSTRUMENTS, INC.). 406**

**Nine-digit frequency counter** operates from 30 Hz to 500 MHz; optional plug-in pre-scaler extends range to 800 MHz. Model PM6645 has a counting accuracy of one digit ± the time base error. Input sensitivity is 5 mV. Internal 10 MHz clock has long-term drift of 1.1 ppm per year. Higher-stability clock is available as an option. \$1690. **PHILIPS (TEST AND MEASURING INSTRUMENTS, INC.). 408**

**Pocket-sized digital multimeter** model 245 offers 4½ digits in size 1¾ in.

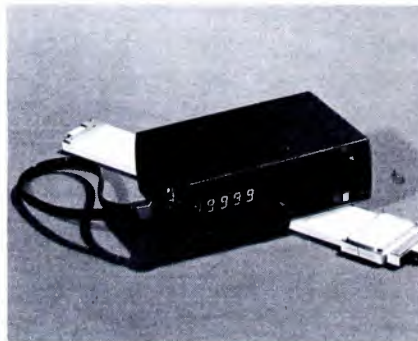

high by 3½ in. deep and 5 in. high. It runs on rechargeable batteries. \$295. **DATA PRECISION. 416**

**Microwave link analyzer** spots troubles in the carrier elements and mod-demod sections of microwave communications systems. The Model 3710 system is a

combined test set for the 45-95 MHz IF band and the 83.3 kHz to 8.2 MHz baseband. With optional up-converter and down-converter, it measures performance of RF devices from 1 to 13 GHz; it can be configured to measure across any combination of baseband, IF or RF device. The system measures group delay linearity, modulator sensitivity, attenuation, return loss, demodulator sensitivity, differential phase, differential gain. Transmitter, \$3820; analyzing receiver, \$4935; group delay plug-in; \$850; differential phase plug-in, \$1110. **HEWLETT-PACKARD. 410**

**FM stereo signal generator** has a pilot signal frequency of 19 kHz with ± 2 Hz accuracy. Model LSG-231 has a 1 kHz audio signal accurate to ± 1%, is specifically designed for field or workbench applications. \$229.95. **LEADER INSTRUMENTS CORPORATION. 411**

**Portable wow, rumble and flutter meter** meets broadcaster's requirements. Metering is accurate to 0.01%. Unit can be used as a voltmeter and contains a built-in oscillator. \$495. **CCA ELECTRONICS (REK-O-KUT). 413**

**Digital voltmeter**, Model 281, has automatically positioned decimal point, 100% overrange capability, 1% accuracy, 2½ digits, and 10 megohms impedance. Also features overrange indication. \$169.50. **DYNASCAN CORP. (B&K). 414**

**Digital panel meter** 8330 mounts on an instrument's front panel, rather than through it, for greater heat immunity. Available in 3½ (0.1%) or 2½ digit versions. \$140. **CALIFORNIA INSTRUMENTS. 415**

## The all-in-one medium.

Okay, so you've just finished airing your documentary on the bicycle boom. A few days later you get a call from the president of a local men's club and he wants to show it at their weekly meeting on Tuesday. "Sure," you say, and send him the film.

Or, after hearing about a contest for documentaries, you immediately pull a film you did on an old house in town which has been converted into a recreation center for teen-agers. Because it's on film, you can enter it as is, something you couldn't do if it had been shot on tape.

Flexibility is one of the many beauties of film. Once a film is in the can, it can go and show practically anywhere. On the screen. At sales meetings. In flight. Off the beaten path.

So you can see that calling film the all-in-one medium is more than just a catchy phrase.



**EASTMAN KODAK COMPANY** ATLANTA Bob Baker 404/351-6510/  
CHICAGO Dick Potter 312/654-5300/DALLAS Frank Reinking 214/351-3221  
/HOLLYWOOD John Waner 213/464-6131/NEW YORK Bill Reddick 212-262-  
7100/SAN FRANCISCO Joe Semmelmayr 415/776-6055

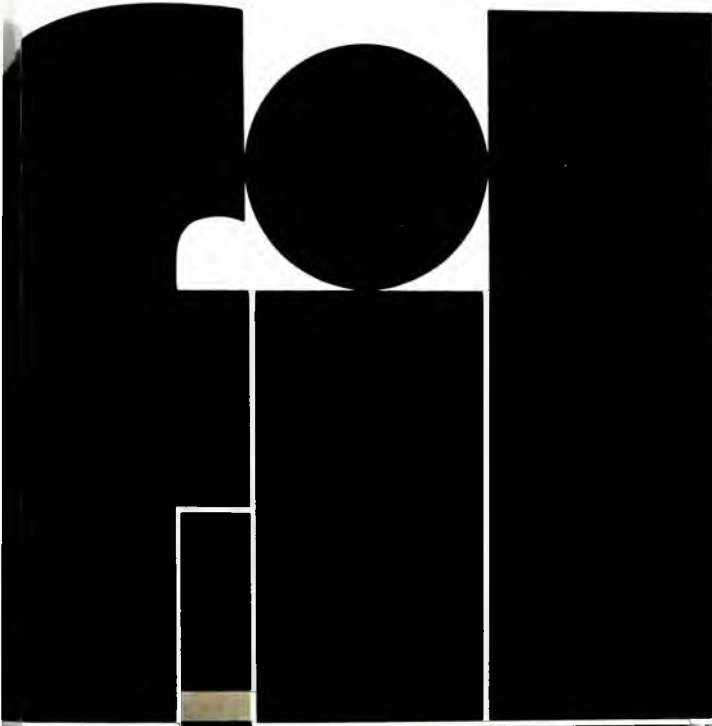



# WOULD YOU BELIEVE A PEAK LIMITER WITH INSTANTANEOUS ATTACK AND DISTORTION SO LOW YOU CAN MAKE PROOF THRU IT



WILKINSON ELECTRONICS LA2-C/S  
STEREO OR MONO

- \* DISTORTION – ¼% for 6db of limiting.  
1% or less to 20db of limiting.
- \* ATTACK TIME – 5/4 Radians for gain control before clipping.
- \* OVERLIMIT ATTACK TIME – Instantaneous.
- \* COMPRESSION RATIO – More than 35:1.
- \* FREQUENCY RESPONSE – + 1db 50Hz to 35KHz with full limiting.

# A NOISE FREE AGC AMPLIFIER WITH A DYNAMIC RANGE PRESERVER



WILKINSON ELECTRONICS GCA-1  
STEREO OR MONO

- \* NOISE – -75db even with loss of input. Automatically “rides” gain without regard to peaks. Exclusive RMS Detector preserves dynamic range. Will not adjust gain if signal removed.
- \* DISTORTION – 0.1% all gain settings.
- \* FREQUENCY RESPONSE –  $\pm$  ¼db 50Hz to 20KHz any gain setting.

NO ONE IN THE WORLD CAN MATCH THIS COMBINATION

**WILKINSON**  
ELECTRONICS, INC.

1937 W. MacDADE BLVD.

WOODLYN, PA. 19094

TELEPHONE (215) 874-5236/874-5237

# BROADCAST EQUIPMENT

**Audio-video switching systems** for retrieval or routing with large numbers of sources and destinations, have solid-state two-circuit switching at each cross-point of the dual matrix system. The AVS-700 Series uses input plug-in assemblies, each holding  $20 \times 20$  crosspoint pair groups, and output sub-assemblies providing  $10 \times 20$  crosspoint pair groups, plus 20 dual output amplifiers, allowing the matrix to be assembled in various sizes. A number of control methods are available such as dial access, touch tone access, locking or momentary pushbuttons, or computer control with random or clocked (vertical interval) execute. Basic internal crosspoint controls is decimal, which can be converted to BCD for large systems, with basic 5-volt logic. **RIKER COMMUNICATIONS, INC.** 275

**"Portable" television production studio** consists of portable VTR and camera, lighting equipment, audio pickup equipment, and modular control con-



sole. TV mod has all units in carrying cases for easy transport and quick set-up where needed. **CLOSED CIRCUIT TELEVISION CORP.** 276

**Miniature SPST coaxial relay** switches signals up to 1 GHz, with loss less than 0.35 dB at that frequency. Model A1600 occupies a volume of 0.2 cubic inch, is coaxially shielded to a 50-ohm match. Pulses with rise time faster than 150 picoseconds are transmitted with undetectable distortion. Operate time is faster than one millisecond. \$20 in production quantities. **FIFTH DIMENSION, INC.** 278

**Parabolic antennas with** guaranteed radiation patterns have 15-, 30-, and 45-foot diameters. Series has broadband feed. The 15-footer (for VHF channels 7-13 and UHF 14-83) has a guaranteed front-to-back ratio of 40 dB for VHF and 45 dB for UHF. The 30-footer has 45 dB ratio on VHF 7-

13; 45-footer with mesh is 35 dB for VHF 2-6 and 43 dB for VHF 7-13. **RF SYSTEMS, INC.** 279

**Stereo headphones** include Model 839-20 with separate woofer and tweeter design, and volume and tone controls for each earpiece. Also in series are Models 839-18, 839-18, and 839-17. \$19.95 to \$59.95. **ZENITH.** 280

**Monochrome video projector** puts a television image on screens 3 feet to 24 feet wide. Model 10 projector works from off-the-air TV signals, videotapes, videocassettes, live TV cameras, cable TV, closed-circuit TV, or computer-driven video generators. Control box can be used remotely. Push-button VHF/UHF tuner and speaker are included. \$3950.00. **VIOR CORPORATION.** 281

**Computer-output line printer** has 600 lines a minute speed. 80-column or 132-column models, prints seven clear copies. Variable-width model takes paper from  $3\frac{1}{2}$  in. to  $19\frac{1}{2}$  in. Installations are available for Honeywell 316, 516; Nova and Super-Nova; Varian 620/i and 520/i; DEC PDP-8 and 11; Hewlett-Packard 2114, 2115A, 2116B; and IBM 1130. **PER DATA, INC.** 282

**Four-channel stereo headphones** have two channel/four channel switch, a new pressure-type dynamic driver. Models PRO-5Q, KO-747Q, and K-6LCQ, have volume and balance controls. Prices are \$70, \$55 and \$39.95, respectively. **KOSS CORPORATION.** 283

**New klystron tubes for UHF-TV** are 4-cavity, vaporecooled, 470-860 MHz, have up to 40% efficiency and a gain of at least 35 dB. Models VA-890H, VA-891H, and VA-892H directly replace earlier models VA-890A, VA-891A, and VA-892A, respectively, with considerably higher transmitter output, improved linearity, or both. Less than 10 watts of rf drive is necessary to produce a 32-kilowatt peak-of-output with any one of the new series. **VARIAN.** 284

**Cathode-ray tube for color film scanning** uses a GGO phosphor, is magnetically focussed and deflected. Model MX71 has a non-solarizing faceplate with neutral density tint, provides both positive and negative scanning. Very short persistence reduces need for de-

streaking. **GENCOM DIVISION, EMITRONICS.** 285

**Loop antenna for magnetic field measurements** in the range of 150 kHz to 32 MHz collapses for easy portability. Frequency bands are chosen with six switched coupling transformers. Loop is 52 in.  $\times$  46 in.  $\times$  5 in., may be used with any 50-ohm RFI meter or calibrated receiver. **SINGER INSTRUMENTATION.** 286

**Five-channel rack-mount audio control unit** takes only  $3\frac{1}{2}$  inches of rack space. The Accu-Five accommodates up to 13 microphone inputs, has full program, monitor, and cue facilities. \$495.00. **MCMARTIN.** 287

**Audio broadcast consoles** are available in mono and stereo versions, with 6 or 10 faders. "Futura" series have slide at-



tentators, plug-in electronics, switchable meters, independent audition and program channels. \$1095 to \$2495. **CCA ELECTRONICS CORP.** 277

**Cylindrical parabola antenna** for 952-960 MHz band has a vertical beamwidth of 36 degrees, forward gain of 12 dB with all minor lobes at least 14 dB down. Model 628-309 has horizontal beamwidth of 19 degrees, front-to-back ratio of 20 dB, maximum power input 100 watts. **PHILIPS DODGE.** 288

**New supplemental products for Model 44 time-base corrector** include a Time Base Director, Model 28, which extends capability of the 44 to heliscan "electronic editor" VTRS, older quad VTRS not equipped with intersync or Pixlock, and some line-locked cassettes and reel-to-reel VTRS, in monochrome and NTSC versions. \$1650 up. Other new supplementals are head servo drift suppressor; head velocity error corrector; and full-line drift corrector. **TELEVISION MICROTIME, INC.** 289

continued on page 42



# YOUR BEST COMBINATION FOR FM COVERAGE!!



25KW FM

CCA offers a complete line of field proven FM transmitters from 10 watts to 50KW. Features include 75% plate circuit efficiency, minimum tube life 10,000 hours with zero bias triodes, 65 db signal to noise, distortion less than 0.3%.



## CCA TRUE CIRCULAR ANTENNA

CCA circular antennas are available in low and high power versions with antennas from one bay to 16 bays. Null fill and beam tilt together with radomes permit the broadcaster to obtain coverage where he desires with reliability.

**CCA ELECTRONICS CORPORATION**  
GLOUCESTER CITY, NEW JERSEY 08030 • (609) 456-1716

Canadian Subsidiary:  
CALDWELL A/V EQUIPMENT CO., LTD.  
1080 BELLAMY ROAD, NORTH  
SCARBOROUGH, ONTARIO, CANADA  
Phone: (416) 291-5595  
NO. 1 AM & FM

Circle 119 on Reader Service Card

## PRODUCTS

**Remotely-operated gain control for sound systems** allows level to be adjusted with rises and falls in the ambient noise level, from a position in the covered area. Model 668SP1 consists of an attenuator, installed near the audio gear, and a remote actuator that can be hundreds of feet away. FAIRCHILD SOUND EQUIPMENT CORP. 290

**Stereo FM modulator** is designed to put FM signals on CATV, ETV, or hotel systems. Model FMSM-9172 has automatic modulation controls, phase-locked VCO, crystal-controlled up converter. \$525. FUNG ENGINEERING CO. 291

**Time-date generator** puts the time and date on video screens. Model 3201 uses power line frequency or an external standard for timing accuracy.



Built-in 100-year calendar circuit corrects for length of month and leap year variations. Characters 28 TV lines high can be switched to black or white. \$895.00. LAIRD TELEMEDIA INC. 292

**Miniature portable mixer** has five mike inputs each with condenser mike powering, low frequency roll-off, presence boost, pan-pot and full high and low equalization, AMI Portable Stereo Mixer runs on 12 internal AA penlight cells or on external power supply, weighs 7 pounds including batteries, matches in size the Stella-Vox SP-7 miniature recorder. STELLAVOX (Gotham Audio Distributor). 293

**Digital music maker** can be used to produce jingles, station IDs, news tags. "Digitone" has a 16-tone sequence which can be varied endlessly by user. Monitor speaker is built in, 600-ohm output is provided for feeding tone sequences to consoles. AUDIO/VIDEO PRODUCTS. 294

**New series of television camera tubes** includes: C23084F and C74137A, return-beam vidicons with 4500 and 7000 line resolution, respectively; new vidicon family, RCA-7735, with grades for industrial, scientific and

continued on page 44

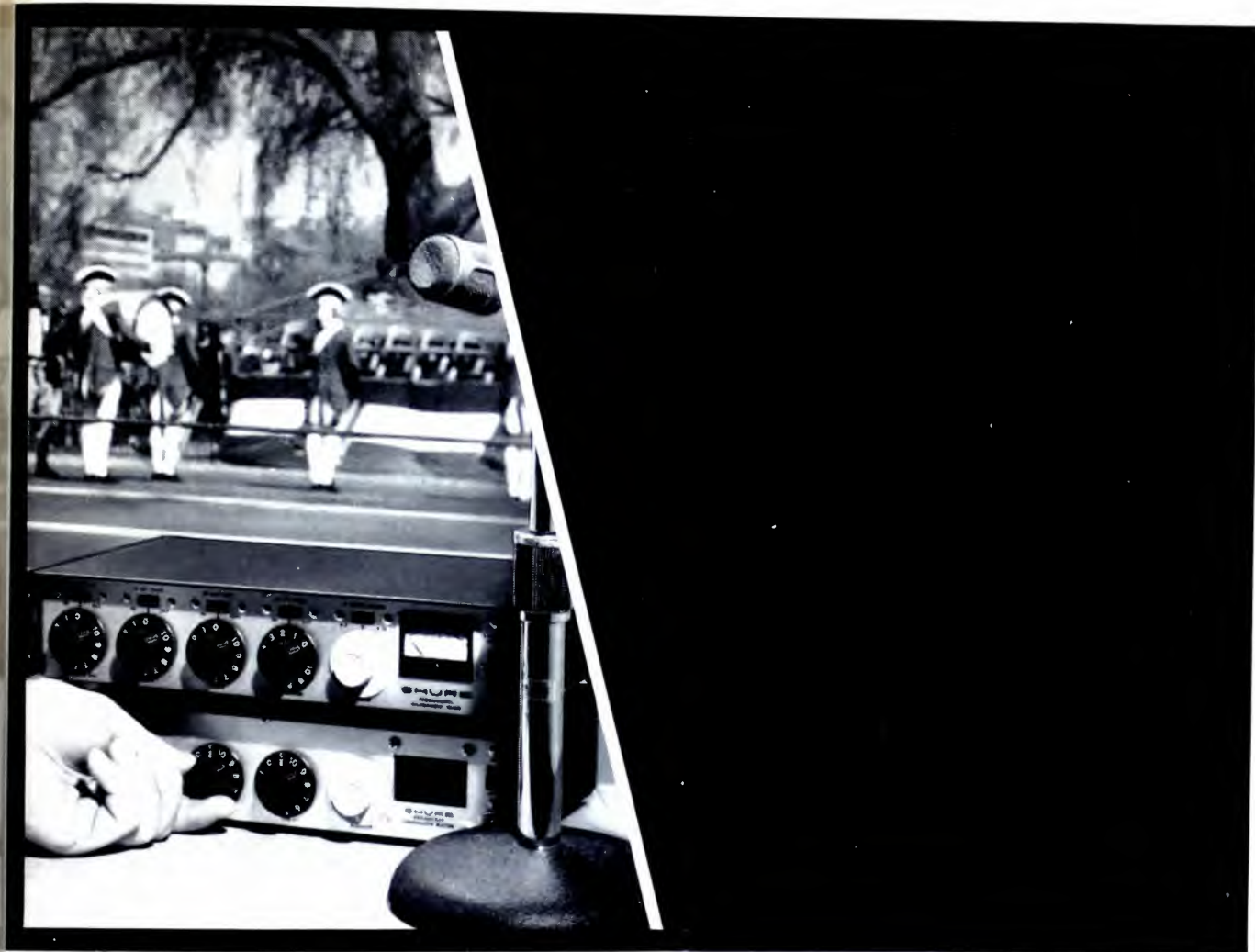

## A production console\* for \$312 !

Eureka! A complete remote and studio production console for a fraction of what you'd expect to pay for a console with comparable features and performance! Simply purchase a new *Shure M675 Broadcast Master* and the extremely popular *Shure M67 Professional Microphone Mixer*. By combining these two units\*, you get inputs to handle microphones, turntables, phone lines and tape machines — *with cuing provision on line and magnetic phono inputs*. Result? A versatile low-noise, low-distortion broadcast production console for in-studio, remote, and standby assignments; a complete CATV console; a studio production console. All for \$312! For complete technical data, write:

Shure Brothers Inc.,  
222 Hartrey Ave., Evanston, Ill. 60204.



\*Each model is also available separately: M67 — \$162 net; M675 — \$150 net.

Circle 120 on Reader Service Card





**Variable-directivity  
condenser studio  
microphone provides  
130 dB dynamic range.**



**Dynamic range (130 dB)  
+ noise level (24 dB)  
= max. spl (154 dB)**

Sony's variable-directivity (Omni-Uni) C-37P\* contains an advanced FET amplifier. A switchable attenuator is placed between the capsule and amplifier to prevent distortion even at extreme sound pressure levels.

The combination of proven excellence in sound quality, and the very latest in semiconductor technology makes the Sony C-37P indispensable in today's quality-oriented recording studio.

Also Consider:

Studio standard condenser microphone model C-500.\*

**SONY SUPERSCOPE**

\*Must be powered by Sony AC 148A or equivalent power source.

©1972 Superscope, Inc., 8215 Vineland Ave., Sun Valley, Calif. 91352. Send for free literature.

Circle 121 on Reader Service Card

## PRODUCTS

broadcast use; RCA-8541 vidicon family, with high resolution, high sensitivity and low lag; and RCA-4826 SIT family for very-low-light applications. RCA. **295**

**Splice finder/erase unit** finds splices in tape, sets cart so splice is an inch beyond pressure roller and recording will be on splice-free tape. Model SF/E-1 also has built-in bulk eraser. UMC ELECTRONICS. **296**

**Thin-film, wideband microwave amplifiers** in two series cover 1-2 GHz and 2-4 GHz, respectively. Models UDP-2032 and UDP-4000 are in 14-lead DIP packages, weigh 0.15 ounce each, have a minimum of 24 dB gain, noise figures of 5.5 dB and 9 dB respectively. \$550 up. AVANTEK. **297**

**Crystal oscillators** have aging rate of 5 parts in  $10^{11}$  per year, are in can  $2\frac{3}{4}$  in  $\times$  2 in  $\times$  2.4 in. Model 10543A is for 5 MHz, 10544A for 10 MHz, with other frequencies in the range available. \$850 and \$450 respectively. HEWLETT-PACKARD. **298**

**Multiple-H line rate generator** is crystal controlled, provides rates of 525, 875, 945, 1023. Model 3519A has outputs



for horizontal drive, vertical drive, composite blanking, and composite sync. TELEMET COMPANY. **299**

**Low-light TV camera** resolves ten shades of grey with only  $2 \times 10^{-3}$  footcandles highlight illumination on the vidicon faceplate (a cloudy moonless night). 2856 Series are intensified silicon intensified target vidicons, with automatic adjustment to light levels, over range of 20 million to 1. COMU. **300**

**Portable tape recorder** covers 2.5 Hz to 35 kHz, for scientific and instrumentation applications on  $\frac{1}{4}$ -inch tape. Model SJ weighs 15 pounds, operates on internal batteries, splits frequency range into two parts—2.5 Hz to 3.5 kHz and 25 Hz to 35 kHz—selectable by switch. Two tracks record full range, a third does dialogue, timing, cue information. It has A-B- continued on page 46

## Sony's award presenting microphone.\*

\*Used at Academy Award and Emmy Award T.V. presentations 1972.

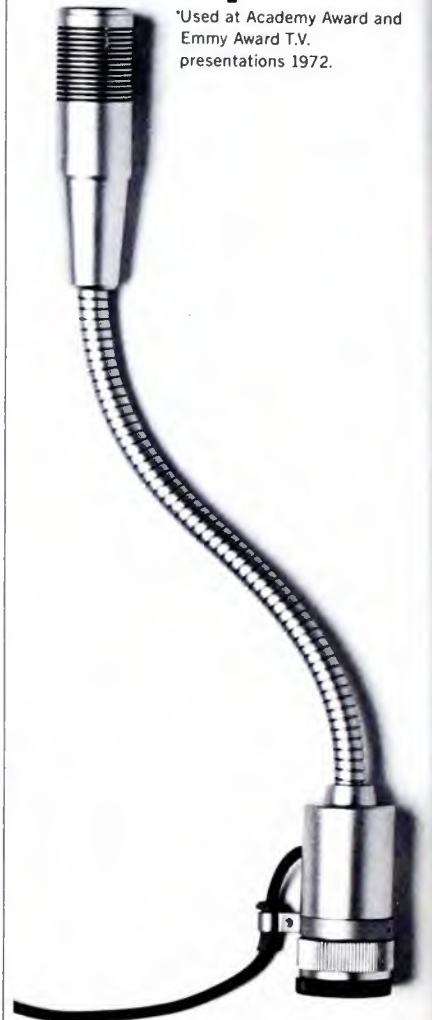

Featuring a high-performance condenser capsule of electret design, the ECM-53 is specifically designed for broadcast, recording studio, public address and similar applications.

The cardioid capsule assembly contains a permanently charged condenser capsule and FET/IC amplifier. A Cannon connector houses the battery supply.

- Frequency Response: (Frontal  $\pm$  3 dB): 40 Hz to 16 kHz
- Output Impedance (at 1 kHz  $\pm$  20%): 50, 250, 600 ohms Balanced
- Maximum SPL (1 kHz): 134 dB

Also Consider:

Tie-tack/lapel condenser mic ECM-50.

Telescopic (from  $7\frac{3}{4}$ " to  $17\frac{1}{2}$ " condenser mic ECM-51.

**SONY SUPERSCOPE**

©1972 Superscope, Inc., 8215 Vineland Ave., Sun Valley, Calif. 91352. Send for free literature.

Circle 122 on Reader Service Card

# VIDEOSKOP & SIDEBAND ADAPTER to MEASURE VIDEO SYSTEMS WITH COMPOSITE SIGNALS.

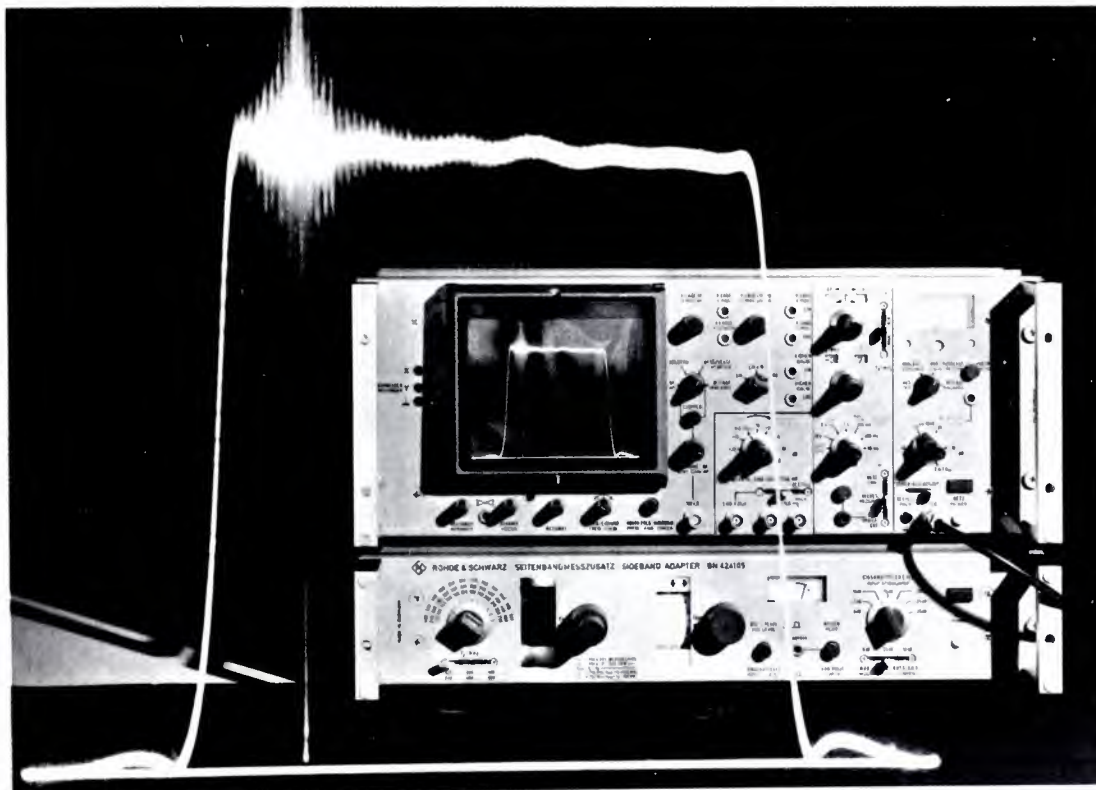

## FEATURES :

Complete test system : Sweep Signal Generator, Selective Tracking Receiver (2 kHz BW), large screen display, in a single cabinet. 75  $\Omega$  VF, 50  $\Omega$  RF.

Freq. Range : 10 kHz-20 MHz or with sideband adapter 30-1060 MHz (display -10 to +20 MHz about carrier)

Sweep :  $\Delta f$  sweep  $\pm 100$  kHz to  $\pm 1$  MHz  
50 ms to 80 s (X-Y Recorder Output)

LIN (30 dB) and LOG (50 dB) display with 30/50 dB dynamic ranges.

LIN  $\times 10$  range with resolution better than .01 dB.

Use as sweep source and plotting detector with R/S Type LFM Envelope Delay Test Set.

Chopper operation for simultaneous presentation of two input signals, e.g., frequency response, envelope delay.

Double control facility in display section for magnification of a particular section of frequency response.

## APPLICATIONS :

Display of frequency response and envelope delay on VF system in presence of sync/blanking pulses (sweep with composite video).

Measurements on transmission links (with tracking receiver).

VIT measurements

Sideband analysis 30 MHz to 1060 MHz (with sideband adapter).

Spectrum Analyzer

## MEASURE

Absolute and relative amplitude-frequency response  
Return loss

Sideband characteristics of TV Picture Transmitters  
End-to-end transmission characteristics on cables and radio links

Characteristics of TV Receivers, Demods, Filters and Amplifiers

Simultaneous Frequency Response and Envelope Delay

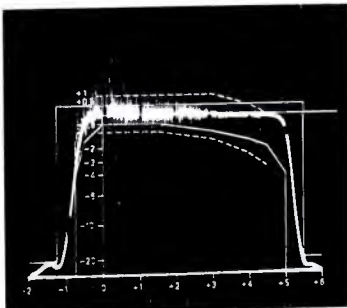

Display of sideband characteristic of a VSB TV channel Signal Generator (SBTF). Test requirement : sweep signal component in composite picture signal 10% of picture signal, set-up at picture white. Combining swept-frequency operation with analysis permits the test signal to be easily observed and measured between the spectral lines.

Videoskop is a highly reliable solid state visual display sweep frequency system covering the range of 10 kHz to 20 MHz. A sideband adapter is available to include VHF and UHF up to 1060 MHz and permits measurement of sideband characteristics to within 10 kHz of TV picture carrier. Type SWOF III Videoskop provides an automatic display of the amplitude response of a test item instantaneously. There is also a facility for manual sweeping (point by point tuning) for use as a CW signal generator. Level meter, calibrated switchable/continuously adjustable input and output attenuators and marker generator permit absolute measurements. Selective tracking receiver makes possible plotting of characteristics of TV systems in the presence of sync and blanking pulses. It further eliminates errors due to harmonics and can be used as a spectrum analyzer. Measuring range is -100 dB to +70 dB. Chopper operation is available for simultaneous presentation of two input signals, e.g., frequency response, envelope delay with Type LFM Envelope Delay Test Set. The display section has double control facility for magnification of a particular section of the frequency sweep. The long sweep time (adjustable from 50 ms to 80 s) is used for test items with long delay times or for use with an X-Y Plotter. Accessories available : Tracking Unit for link measurements; Precision Freq. and Marker Generator, adjustable to 1 kHz throughout sweep range and displayed to 5 digits.



Get The Extra Capability,  
Greater Reliability, and  
Longer Useful Life Of . . .

## ROHDE & SCHWARZ

111 LEXINGTON AVENUE, PASSAIC, N. J. 07055 • (201) 773-8010

Western Office: 510 S. Mathilda Avenue, Sunnyvale, Calif. 94086 (408) 736 1122

Circle 123 on Reader Service Card



# ALL-IN-ONE SPORTSCASTER HEADSET

This sportscaster can roam about a football field, rubberneck at a basketball game, or quickly position himself for an important golf shot. All with just one piece of equipment. The new Telex CS-90 Sportscaster headset lets him broadcast live (fixed station or mobile) listen to production cues, and monitor his own transmission, all with hands free convenience.

He can do all this because Telex has now combined the finest professional microphone available, one of proven broadcast quality, with an equally high-performance headphone.

This wide-range, dynamic, boom microphone has a low frequency response to transmit his voice clearly and crisply, and an omni-directional design to pick up colorful crowd noise. The two channel headphone fits comfortably with a padded headband and foam filled earcushions to screen out ambient noise. It is adaptable to any application or equipment by means of non-terminating cordage and features exclusive Telex audiometric type driver elements. And both headphone and microphone are designed to stand up even if the sportscaster has to work in all types of weather extremes and can't avoid some hard bumps. In fact, if the sportscaster doesn't hold up as well as the CS-90, there is a "push-to-cough" switch that mutes the mike when necessary.

Constructed of high-impact ABS plastic and stainless steel. Styled in non-reflective black and grey to eliminate glare on camera. Write for further information.



PRODUCTS OF SOUND RESEARCH

## TELEX®

COMMUNICATIONS DIVISION

9600 ALDRICH AVENUE SOUTH  
MINNEAPOLIS, MINN. 55420

CANADA: DOUBLE DIAMOND ELECTRONICS LTD. Scarborough 4, Ontario  
EUROPE: ROYAL SOUND COMPANY INC. 400 North Main Street, Freeport, N.Y. 11520 U.S.A.  
INTERNATIONAL: TELEX EXPORT DEPT. 9600 Aldrich Ave. So. Minneapolis, Minn. 55420 U.S.A.

Circle 124 on Reader Service Card

## PRODUCTS

C-D weighting filters, precision 90 dB attenuator with 1 dB vernier, and speeds of 15, 7½, 3¾ and 1.5 ips. NAGRA. **301**

TV-news 16mm camera has built in sound recording for one-man sight and sound operation. Model CP-16/A has complete microphone input and



recording amplifier, with headphone monitoring. Whole unit weighs 16 pounds, is for on-the-shoulder shooting. Recording can be internal, on film, or through output to a separate tape machine. CINEMA PRODUCTS. **302**

Portable FM transmitter-receiver acts as "handie-talkie," with 5 watts output in the 136-174 MHz and 3.5 watts in the 406-420 and 450-470 MHz bands. "Converta-Com" RF unit also plugs into second unit which supplies power and 10 watts audio output, with separate loudspeaker, for mobile operation. MOTOROLA. **303**

Low-light TV camera for surveillance and scientific applications has three-stage image intensifier, with amplification of more than 100,000. Model 2001 has fully automatic adjustment to light levels over a range of one billion to one—camera produces bright pictures in levels from black night to full daylight. DYNA-VISION INTERNATIONAL. **304**

Broadband RF power amplifier puts out 10 watts in the 10 Hz to 10 MHz



range. Model RF-825's output impedance is 3 ohms, can drive R-L-C loads of any impedance. Operation to 20 MHz is available at reduced output. Harmonics and intermodulation are 50 dB down at 10 watts, hum and noise 70 dB down. RF COMMUNICATIONS, INC. **305**

Multi-speed tape transport has three—  
continued on page 48



# INTRODUCING THE ALL NEW... DITCH WITCH R30 ...MORE THAN A TRENCHER!

The **R30** is the all-new 30-horsepower trencher from **DITCH WITCH**. But it's much more than a trencher. It's got more to give you more for your equipment dollar. The **R30** incorporates the ultimate in trencher design — what we call the modular concept. In the **R30** you get a basic trencher vehicle that's the most rugged and dependable in its class. And there's a selection of optional modular attachments that are quickly and easily interchangeable. You pick the modular set-up to fit **YOUR** needs. Put a utility backhoe on the front and a vibratory plow attachment on the back. Add the new Pavement Breaker. Or a front-end loader or a clean-sweep broom. The **R30** gives you more versatility than anything in its class. Let us provide you with more information on the new **R30**. Better yet, we'd like to bring one to your job site and demonstrate it for you. We think once you've seen the **R30** in action, you'll agree that it is more than a trencher.



UTILITY BACKHOE



PAVEMENT BREAKER



FRONT-END LOADER

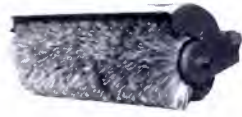

BROOM



VIBRATORY PLOW



A Division of **CHARLES MACHINE WORKS, INC.** P.O. Box 66 Perry, Oklahoma 73077

Circle 125 on Reader Service Card



**15 day free trial shows you why ITC tape cartridge equipment is an industry leader.**



**SP SERIES REPRODUCER**

A two week test in your own broadcast facilities is the only fair way for you to evaluate the performance of ITC's premium line cartridge equipment. Advertising statements are no longer simply claims, but become actual facts proven first hand. Find out for yourself how ITC has built in all the features demanded by broadcasters since tape cartridge equipment was invented. If ITC equipment fails to measure up, you're under no obligation. You'll find that ITC dependability is something on which you can rely completely.

**RP SERIES RECORDER/REPRODUCER**



**Call us collect to arrange a 15 day free trial 309-828-1381**

**it INTERNATIONAL TAPETRONICS CORPORATION**

2425 South Main Street, Bloomington, Illinois 61701

Circle 126 on Reader Service Card

**PRODUCTS**

motor drive, silicon solid-state control circuitry, provision for four heads. Analog Tape Transport is available for 1/4-inch, 1/2-inch or 1-inch tape, has six switch selectable speeds from 1 7/8 ips to 60 ips, other speeds on special order. Capstan speed is set by synchronous phase-lock system referenced to crystal oscillator. Continuously variable speed available with external VFO. PER DATA, INC. **306**

**CB two-way radio** covers all 23 channels with crystal-synthesizing frequency technique. Model 2376A develops full 5-watt power, has a local/distance selection, with the latter taking advantage of low noise in rural areas. Six-section tuned filter, plus series gate noise limiting, gives large s/n ratio. \$159.95. PACE COMMUNICATIONS. **307**

**Co-channel rejection unit** for TV channels 2 through 13 will reduce interfering channel by 20 to 30 dB. Unit measures 9 in. x 3 in. x 3 5/8 in. Single-channel model. \$750. RF SYSTEMS, INC. **308**

**Time-lapse video recorder** records both video and audio on compressed-time basis for permanent program record. Model TL-550 provides 24 consecutive hours of uninterrupted play without rewinding, putting transmission of an entire day on one reel of tape. GYYR PRODUCTS. **320**

**Time announce system** gives call-out of time minute-by-minute on a 24-hour basis. Model 702 consists of a special tape transport and recorded voice announcement of time, may be connected to any standard logging equipment. \$800 for machine; \$55 for tape (purchaseable separately). TAPE-ATHON CORP. **321**

**Mixing console** for audio has eight input modules, each with three-position input pad. Model 10 includes four sub-master modules, a master module with straight-line fader and four 4 in. VU meters. Each input module has equalizers, echo send and receiver circuits, pre- and post-selection, pan pot. Board can accept four additional input modules, or other options, including talkback, remote control, etc. TEAC. **322**

**Heavy-duty light stands** support Seniors, Tanners, lightweight arcs and the Maxi-Brute. Senior Stand extends to a high of 10 ft. 8 in. and collapses to 54 1/4 in. Low stand extends to 45 in., collapses to 27 1/2 in. \$135 and \$95. BERKEY COLORTAN. **323**

**No. 1 number for tape cartridge equipment 309-828-1381**



**3D SERIES REPRODUCER**

A collect call to the above number will bring you all the facts you need to know about tape cartridge equipment. One call will establish a working relationship between you and our broadcast oriented people...a relationship that delivers dependable performance at a truly competitive price. The relationship will last as long as you use ITC equipment...in the selection of equipment, proper servicing, and adaptation of machines to your broadcast requirements. If you're thinking tape cartridge equipment, find out why hundreds of stations depend on ITC.

**WRA SERIES RECORDING AMPLIFIER**



**Call collect for information on free trial and leasing plans**

**it INTERNATIONAL TAPETRONICS CORPORATION**

2425 South Main Street, Bloomington, Illinois 61701

Circle 127 on Reader Service Card

# Canon offers the perfect zoom lens for the camera of your choice

P10 x 20B1



P17 x 30B1



P17 x 30B2



PV10 x 16B



PV17 x 24



PV10 x 15



More and more people are discovering how significantly superior Canon Zoom Lenses are for TV broadcasting purposes. Their outstanding color characteristics, even in dim light, is one of the many reasons why Canon was chosen for telecasting the Munich Olympics. Canon's wide range of excellent zoom lenses encompass three types of operation control— all-servorized, via flexible cables and by effortless push-pull rod control. And it can be attached to

fit and operate with any make of TV camera. Shown on this page are only a few examples of the quality lenses Canon has available to more than meet your particular demands. Specify Canon to stay ahead.

The following are Canon TV Zoom Lenses for the Plumbicon® color cameras currently available on the market:

Size of image tube	Lens	Image format covered
1 1/4" Plumbicon® color camera	P10 x 20B4	17.1 x 12.8mm (21.4mm $\phi$ )
	P17 x 30B1	
	P17 x 30B2	
1" Plumbicon® color camera	PV10 x 16B1	12.8 x 9.6mm (16mm $\phi$ )
	PV10 x 15B2	
	PV17 x 24B1	
	PV 6 x 18B1	

® Reg. TM N.V. Philips of Netherlands.

#### The Canon TV Lenses Naming System



Applications	Image Format	Pick-up Tubes
P	21.4mm $\phi$	1 1/4" Plumbicon
PV	16mm $\phi$	1" Plumbicon

Apart from the above, Canon has available TV zoom lenses for 3" or 4-1/2" image orthicon cameras and can also build special lenses to fit your requirements.

# Canon

● CANON U.S.A., INC.: 10 Nevada Drive, Lake Success, Long Island, New York 11040, U.S.A. (Phone) 516 488 6700 ● CANON U.S.A., INC. 457 Fullerton Ave., Elmhurst, Illinois 60126, U.S.A. (Phone) 312 833-3070 ● CANON OPTICS & BUSINESS MACHINES CO., INC. 3113 Wilshire Blvd., Los Angeles, California 90005 U.S.A. ● CANON AMSTERDAM N.V.: Gebouw 70, Schiphol Oost, Holland ● CANON LATIN AMERICA, INC.: Apartado 7022, Panama 5, Panama ● CANON INC. 9-9, Ginza 5 chome, Chuo ku, Tokyo 104, Japan

Circle 128 on Reader Service Card



**Some of our substitutes  
for those big, fat incandescents.**

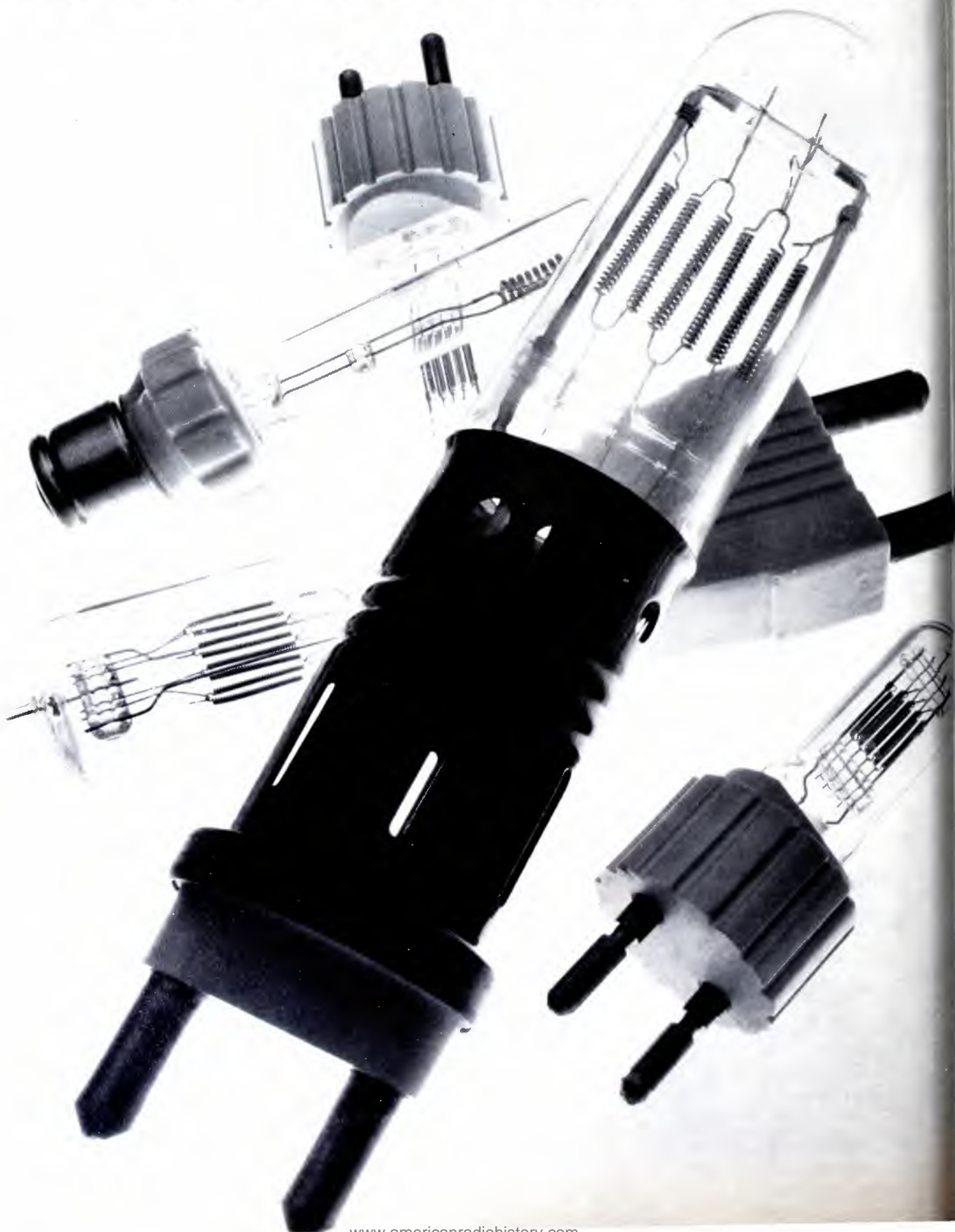

# Some of our substitutes for our substitutes.



Those big, fat incandescents blessed the world with a lot of big, fat fixtures and sockets.

So after we came up with our skinny, little tungsten-halogen lamps, the first thing we had to do was set them up on big, fat bases so that they'd fit the old sockets.

Which meant developing a complete line of Substitution Lamps. (You see some of them at the left.)

But soon new fixtures arrived on the

scene. These took full advantage of the inherent small size of Sylvania tungsten-halogen lamps.

(Which, by the way, outlast the fat incandescents about 3-to-1, don't blacken and lose brightness with age, and don't fall off in color temperature.)

For the new fixtures, we developed a complete new Standard Line of tungsten-halogen lamps, like the ones on the right.

Whenever studios replace their old fixtures with new ones, they can substitute

our new lamps for our Substitutes.

Which is OK with us.

Because both of these lines are so much better than the old lamps, that no matter which our customers use, we feel we've done them a world of good.

And there's just no substitute for that.

We have a brochure on each line. For your copies, write to: Sylvania Lighting Center, Danvers, Massachusetts 01923.

**GTE SYLVANIA**

Circle 129 on Reader Service Card



*NEW from TerraCom:*



# NEW LIT

For copies of these literature offerings, circle number for appropriate items on Reader Service Card.

"Servo-Sound," a high-fidelity system using signals fed back from the speaker cabinets for self-regulation, is covered in illustrated brochure. Servo-Sound America, Inc. **200**

Booklet on use of spectrum analyzer tells how instrument can verify good engineering standards and presents a complete pictorial summary of FCC requirements that can be certified with a portable spectrum analyzer. Tektronix. **201**

Repeater for two-wire loaded circuits, for extending telephone line facilities, is described in new brochure. Reliable Electric Company. **202**

"Microwave Digital Radio Primer" is a new booklet treating digital traffic, digital modulation, T-carrier on microwave radio, and many other subjects in the area. Avantek. **203**

Turntables, tone arms, preamplifiers and related products are listed in eight-page illustrated catalog. Gray Research. **204**

"Metro-Com," a new two-way broadband communications system for cable, using frequencies in the 6-48 MHz band, is fully described in a comprehensive technical booklet. Ameco. **205**

A new price list covers CATV products: co-channel rejection kit, antennas, astrologs, etc. RF Systems, Inc. **206**

"Test and Measuring Notes" is a quarterly magazine discussing measurement technology in depth, including use of new Philips instruments. Test and Measuring Instruments, Inc. (Philips). **207**

Low-cost video tape editing system is covered in four-page technical data bulletin. Datatron. **208**

New 78-page catalog covers 10 series of thumbwheel switches, including complete electro-mechanical details. Electronic Engineering Company of California. **209**

Underground directional taps, for the 5-300 MHz band, are covered in new technical data sheet. Magnavox CATV. **210**



## tunable microwave radio

the universal one  
for TV,  
telephone and data

TerraCom's new microwave radio is frequency agile for use in any band from 1.7 to 15.25 GHz, continuously knob-tuned across each band, and has automatic self-test and fault isolation indications. The TCM-6 Series is this and more. High performance, reliable and really a "universal remodulating radio"... proven in every customer lab test. The most easily maintained microwave radio available. FDM voice (up to 1200 channels), or 10 megabit data, or NTSC color TV—and higher resolution—that includes internal, high quality audio channels. Tripod mount, rack mount, or remote the RF plug-in module at the antenna... no waveguide.

Change frequency band anywhere in minutes by exchanging plug-in RF modules, without external test equipment. If you don't need tunability, buy the TCM-6 in its fixed tuned configuration.

Write or call Bruce Jennings for detailed information at TerraCom, a Division of Conic Corporation—leader in RF Communications Technology since 1961. 9020 Balboa Avenue, San Diego, California 92123. Phone (714) 278-4100.

- TRULY PORTABLE
- FREQUENCY AGILE
- 1.7 TO 15.25 GHz
- TUNABLE OR FIXED TUNED
- TRIPOD OR RACK MOUNT
- INTERFACES WITH ANY RADIO
- BUILT-IN-TEST
- AUTOMATIC FAULT ISOLATION
- WEATHERPROOF HOUSING



"FIRST WITH COLOR TV FROM THE MOON"

Circle 130 on Reader Service Card



equipment is not located in the video master control room. The actual switching will continue to be handled by IBEW personnel." Similarly, another new provision says that any station personnel can enter data in, or extract data from, computer equipment, as long as it's not done in engineer operating areas; manual operation of program switching controlled by the computer must still be done by engineers.

**New Helical VTR by IVC Aims at Full Broadcast Quality**

A radically new helical VTR system, the result of cooperative design effort by International Video Corporation, the Rank Organization in England, and Intertec in the U.S., is designated the IVC 9000. It aims for full broadcast color quality, using two-inch tape and some advanced electronic circuitry. It will be sold by Rank and Thomson CSF, a French company, in certain areas outside the U.S. The dual-head scanning allows a tracking angle of 19.5° and a scanning assembly only 5.24 in. long, providing

20-to-1 advantage over one-inch VTRs in maintaining intermachine exchange. The track pattern includes two high-quality audio tracks as well as the video track, equal or superior to present quadruplex tracks; plus cue, control, and address tracks. (See diagram.) Writing speed is 1500 ips, tape speed 8 ips, giving two-hours playing time on a 10½-in. reel. "Super-high-band" carrier and deviation frequencies, and other state-of-the-art electronics, contributed to the performance quality of the system.

**Burch Says Radio Deregulation Is Coming**

Federal Communications Commission Chairman Dean Burch, in a speech to the CBS affiliates in Phoenix on September 21, said that "de-regulation" of radio, on which broad-ranged study began last April, is high on the FCC active list but will take several years for full development and implementation. He reported more than 400 industry and public replies in response to the FCC invitation for comments on the subject. He said that the FCC had already identified some rules that

might be deleted or substantially revised, and on which the FCC might take action in a few months, among them: station IDs; half-hour meter-reading requirements; mechanical reproduction and rebroadcast rules; five-days-a-week operating inspection; and a variety of logging, filing, and technical requirements.

**News in Brief**

**Reeves Cinetel** of New York will handle syndication and distribution of "That Good Ole Nashville Music," country music series taped at WSM-TV in Nashville . . . **National Center for Audio Experimentation**, at the University of Wisconsin, Madison, has available a number of experimental-sound tapes, most in binaural sound, including music, drama, actuality events . . . **Collins Radio Company** reported sales for the year ended July 28, 1972 at \$250 million, and an operating loss for the year of \$29.2 million.

The **Dolly Holiday** show, late-night music series sponsored by Holiday Inns, announced smoother progression of music with fewer announcements, wider range of styles, and addition of more top 40 artists  
continued on page 54



**TR•E2  
FM/SCA  
EDUCATIONAL  
RECEIVER**

a moderately priced crystal controlled sca receiver designed specifically for educational broadcasting and services to the blind; a product which reflects McMartin's recognized multiplex experience.

**SCA RECEIVERS**

**McMartin**  
605 NORTH THIRTEENTH ST  
OMAHA, NEBRASKA, 68102  
TELEPHONE (402) 342-2753

Circle 131 on Reader Service Card

only  
**975000000**  
to go

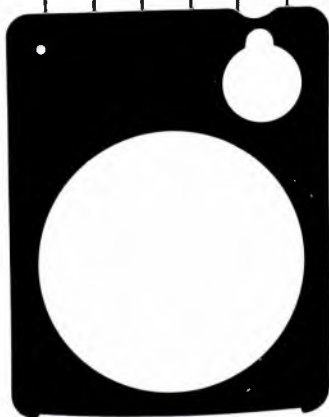

Over 25 million Fidelipac Automatic Tape Cartridges have already been sold and that means our goal of 1 billion isn't really that far away. Because being compatible with all standard broadcast cartridge machines and available in all standard lengths, Broadcasters know Fidelipac. They know its operating superiority, they know its true sound fidelity and they know its long-lasting life. That's why they want it. That's why they buy it. That's why it's the standard for the Broadcast Industry. Get to know Fidelipac yourself. With your help, we'll be able to say, "Only 974,999,999 to go."

For additional information on the *Broadcaster Comprehensive Fidelipac Cartridge Line*, call your local Fidelipac distributor or write to



**fidelipac**

a division of TelePro Industries, Inc.  
3 OLNEY AVE.  
CHERRY HILL, N.J. 08034  
(609) 424-1234

Circle 132 on Reader Service Card



# STOP GROUND-LOOP HUM!

VIDEO  
HUM STOP COIL  
HSC-1

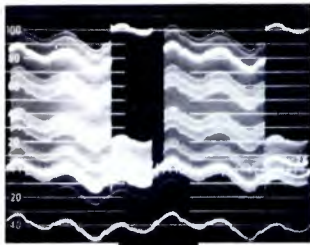

NEW!



NEW!

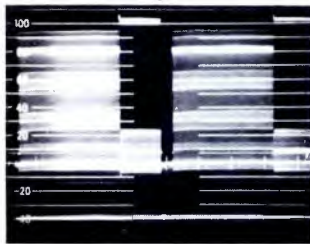

● Will **ELIMINATE HUM** and other **INTERFERENCE** in Video Lines caused by differences in Ground Potential!!

- For Color and Black & White
- FLAT — DC to 6.5 MHz.
- No Low-Freq. or Hi-Freq. Roll-off.
- No Differential Phase Distortion.
- No Differential Gain Distortion.
- No Envelope Delay.
- Reversible.
- Passive Device — Failure Free.
- Small Compact Package 4" x 4" x 2 1/4".
- Low Price.

**\$110.—F.O.B. NY**

**ELIMINATES HUM & INTERFERENCE:**

- **IN FIELD:** Betw. Remote Truck & Telco.  
Betw. Remote Truck & Microwave  
For Intertruck Hookup  
For VTR Units  
For Monitoring Lines
- **IN STUDIO:** Between Buildings  
On long runs in Buildings  
Between Studios & Transmitter  
On incoming TELCO circuits  
On Outgoing TELCO circuits

**AUDIO-VIDEO ENGINEERING COMPANY**  
65 Nancy Blvd., Merrick, N.Y. 11566  
Tel. (516) 546-4239

- Please send Add'l. Inform. on HSC-1
- Please send me . . . . . HSC-1 coil(s).
- Enclosed is remittance of . . . . .
- Please Invoice on 10 day Free Trial

Name . . . . .  
 Station or Co. . . . . Title . . . . .  
 Address . . . . .  
 City . . . . . State . . . . . Zip . . . . .

Circle 133 on Reader Service Card

## NEWS

etc. . . . **Belar Electronic Laboratories** has moved to larger manufacturing quarters on Lancaster Avenue at Dorset in Devon, Pennsylvania . . . **KEWP**, new MOR station in Little Rock, Arkansas, has appointed Grant Webb and Co., with offices in New York, Chicago, and elsewhere, as national reps.

**KWMU**, FM station of the **University of Missouri**, has installed the **RCA** dual 10-kw transmitter, which automatically switches to the remaining unit with reduced signal, if one should fail; in ordinary operation both transmitters generate the signal . . . **Fairchild Sound Equipment Corp.** has appointed Wilkins-Mason of Lafayette, Calif., representatives for northern California, and Robert Milsk Company, Detroit, for Michigan, Indiana and Kentucky . . . **Canadian Broadcasting Company** will install the **Marconi B7318**, 55-kw transmitter, as the second-high-power UHF unit in Canada, for full-time educational programs in French, from a Toronto location.

**Stanton Magnetics** gave annual rep awards to Gene Rosen of Gene Rosen Associates, and Jack Anthony of John B. Anthony Company . . . **Fred Welsh Antenna Systems** opened a new sales office at 2573 Belanger Street East, Montreal . . . **Sanyo Electric, Inc.** has started construction of a new headquarters, warehouse, and showroom building, with 150,000 square feet of space, in the Los Angeles Industrial Center.

**RCA** has sold to the U.S. Army \$1.3 million worth of image intensifier tubes which allow a viewer to sight objects in near total darkness or starlight conditions . . . **Creative Management Associates**, talent agency which represents many top entertainers, anticipates earnings of about \$723,000 for the last six months of 1972, compared to the \$442,953 of the similar 1971 period . . . **Cue Recordings** of New York has opened expanded and updated studios for recording sound and the production of audio cassettes, with on-site duplication.

**Schafer Electronics** of Santa Barbara has formed a Canadian Subsidiary, **Schafer Electronics, Ltd.**, to be located in Calgary, Alberta . . . **Wright State University**, Dayton, Ohio, is presenting a series of lectures through October and November on cable TV and its social implications; info: Wright University, Dayton, Ohio 45431.

## SHIVELY LABORATORIES ANNOUNCES A NEW GENERATION OF CIRCULARLY POLARIZED FM ANTENNAS



TYPE 6810 • 10 KW PER BAY



TYPE 6813 • 3 KW PER BAY



TYPE 6811 • 1 KW PER BAY

**RADOMES OR DEICERS  
AVAILABLE FOR ALL MODELS**

WRITE FOR INFORMATION ON  
ANTENNAS  
TRANSMISSION LINE  
FILTERS  
RF LOADS  
COAXIAL SWITCHES  
POWER COMBINERS



**SHIVELY LABORATORIES,  
INC.**  
**RAYMOND, MAINE 04071**  
**PHONE 207 655-3841**

Circle 134 on Reader Service Card



**TV Cable Company** of Ft. Walton Beach, Fla., installed one of the first automatic weather systems developed by **MSI Television**, Salt Lake City; it uses the NOAA Weather Wire of the National Weather Service to put forecasts on the cable automatically, along with locally-keyed messages.

## People

**James W. Emmick** was appointed director of system and field engineering for Ameco, Inc.; and **Donald B. Gregory** was appointed southeastern regional sales representative . . . **Dom Capano** is the president of a new firm, Cinecraft International, Inc., which will market professional motion picture equipment from Moonachie, N.J.

**Charles K. Lindsey** was named southeastern sales representative for Anixter-Pruzan, with headquarters in Ormond Beach, Fla. . . . **Alfred L. Ginty** is the new vice president, electronics division, of Anaconda Wire and Cable Company . . .

**Thomas E. Rogeberg** was named program manager for the Central Educational Network in Chicago.

**Edward L. Taylor** has been named president of United Video, Inc., common-carrier microwave subsidiary of LVO Cable . . .

**Howard Frost** is the new director of broadcast operations for WHCT-TV, Hartford . . . **Charles A. Brailer** is in the new post of broadcast operations manager at KPPIX, Westinghouse TV station in San Francisco.

**Anthony Frothingham** will succeed **Dr. Norwood L. Simmons** who is retiring as assistant vice president and general manager of Eastman Kodak's motion picture and education markets division . . . **Charles Peterson** was named manufacturing manager for Magnetic Head Operations at Nortronics Company, Inc. . . .

**Harry Rosenblum** became national sales manager, distributor division, of Pickering and Company.

**Benjamin Hughes, Jr.** has joined the marketing staff of Theta-Com of California, in charge of sales promotion for the Cable Division and coordination of all sales east of the Mississippi . . . **Mandel Weiss** was appointed acting president of the Broadcast Division of the S. Jay Reiner Company . . . **Richard Q. De Angelis** is the new general manager of WNEM-TV, Meredith station serving Bay City, Saginaw, and Flint, Mich.

**Paul Adanti** was named a senior vice president of the Broadcast Division of Meredith Corporation; **Larry Rhodes** succeeded him as

vice president and general manager, WHEN-TV, Syracuse . . . **Odin S. Ramsland**, executive vice president of KDAL radio, Duluth, Minn., was elected chairman of the board of the CBS Radio Affiliates Association . . . **Don McDaniel** signed on as a full-time staff director for Jefferson Productions, video production firm in Charlotte, N. C.

**Harry Proudman** was named assistant vice president of the videotape operations of Sony Corporation of America, and will continue as national sales manager of all video products; **Shiro Koriyama** was named assistant vice president and marketing manager . . . **Mathew S.**

**Ceterski** was appointed northwest regional sales manager of Philips Broadcast Equipment Corp., with headquarters in San Mateo, Calif..

**Michael H. Stoll** became industrial sales manager for the Industrial Products Division of Crown International, Elkhart, Ind. . . . **Dr. Lowell I. Smilen** has been named vice president of engineering of Laser Link Corporation; he was most recently engineering leader for solid state phased array systems in the Advanced Systems Department at RCA . . . **Joseph D. Coons** is the new sales director, major markets, for International Good Music, Beltingham, Wash. **BM/E**



# Spotmaster

**Economical  
Tape Cartridge  
Equipment from . . .**

**\$440**

**Pushbutton Broadcasting  
At Budget-Pleasing Prices**

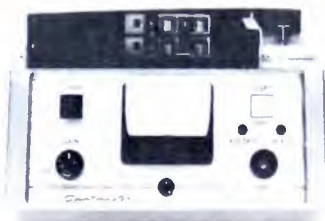

Model 500 C



Model 400 A



Model 500 CR

**COMPACT 500 C SERIES**—Completely solid state, handsome 500 C equipment features functional styling and ease of operation, modular design, choice of 1, 2, or 3 automatic electronic cueing tones, automatic record pre-set, separate record and play heads, A-B monitoring, biased cue recording, triple zener controlled power supply, transformer output . . . adding up to pushbutton broadcasting at its finest. Specs and performance equal or exceed NAB standards. Record-play and playback-only models are available.

**RACK-MOUNTED 500 C MODELS**—The 500 CR rack models offer the same Model C design and performance features and are equipped with chassis slides ready to mount in your rack. Each unit slides out for easy head and capstan cleaning and other routine maintenance.

All 500 C models carry iron-clad full-year guarantees.

**ECONOMICAL 400 A SERIES**—Now even the smallest stations can enjoy Spotmaster dependability with the low-cost, all solid state 400 A series, available in compact record-play and playback-only models. Performance and specifications are second only to the 500 C series.

For complete details about these and other Spotmaster cartridge units (stereo, delayed-programming and multiple-cartridge models, too), write, wire or call today. *Remember, Broadcast Electronics is the No. 1 designer/producer of broadcast quality cartridge tape equipment . . . worldwide!*

**BROADCAST ELECTRONICS, INC.**

A Filmways Company

8810 Brookville Road, Silver Spring, Maryland 20910 • (301) 588-4983





stations by class of station. The ERP for a station can be achieved by a high-power transmitter and a low-gain antenna or, conversely, by a low-power transmitter and high-gain antenna—or something in between. With any combination, the maximum radiation in the main beam has to be the same. How high the antenna is mounted, how near the antenna is to the desired coverage area, and how rugged the terrain is in the coverage area are some of the factors which should be considered in selecting the power/gain combination. Null fill and/or beam tilt can be built into the antenna to tailor the radiation pattern to provide the desired coverage. With about a 15% reduction in gain, a high-gain antenna can be designed to give close-in coverage similar to a low gain antenna.

**Pick a broadband antenna**

Broadbanding of an antenna system is something not well understood by non-technical people. An analogy is the garage door built with only an inch to spare on either side of the automobile. One would have difficulty driving through the door. If, however, the garage door is built with two feet to spare on either side of the automobile, there should be no difficulty in passing through the door. With all the extras riding on the FM carrier today, i.e., stereo and SCA, it is important to have a broadband antenna to insure undistorted stereo and SCA service.

Normally the measure of broadbanding is the VSWR of the antenna over the FM channel. This does not present the total picture since the VSWR could be flat across the channel while the impedance varied across the channel. A better measure of broadbanding would be to specify the percentage change of impedance over the channel.

**A word of caution on circularly-polarized antennas**

Circularity of an antenna can only be specified for free space. Unfortunately a supporting structure must be used to mount the antenna. The size of the supporting structure will determine the circularity of the radiation pattern. For large towers, the radiation pattern becomes rather directional. If coverage in all directions is important and the supporting structure is large, special attention should be paid to the antenna supports and their effect on the pattern. Possibly a special antenna which surrounds the tower should be used.

True circular polarization is rarely achieved except in a free space measurement. As soon as the antenna is mounted on the supporting structure, the amplitude and/or phase of the horizontal and vertical fields will change, producing elliptical polarization. This change in polarization is not important, however, since nearly all receiving antennas are other than circularly polarized.

Because each station's coverage area presents unique propagation problems, the best results from your station can be obtained when the transmitting system is designed for your market. **BM/E**

## Matthey Video Delay Lines



**VIDEO DELAY UNIT UN14/511**

Infinitely variable range of 10-165 ns. in 5 ns. steps, selectable by switches, with fine trim of  $\pm 4$  ns. by screw adjustment. Cascade with fixed delay boxes of 50, 200, 500 and 1,000 ns. 75  $\Omega$ —fully-equalized—insertion loss .1 dB. In service at all three networks, numerous stations.

**Price \$80.00. Try one at no obligation.**

Complete literature and prices on video delays (boxed and PCB modules)—pulse delays—pulse cleaners for under- and over-shoot—low-pass video filters from

**Bill Pegler phone (516) 628-8068**

*Television Equipment Associates*  
**BOX 1391 BAYVILLE, N. Y. 11709**

Circle 135 on Reader Service Card

## Spotmaster

### Compressor-Limiter Amplifier



**(The Great Leveler)**

# \$445!

You can stop riding gain now, even when a shouter and whisperer are on the same talk show. The Model CLA 20/40 Compressor-Limiter Amplifier does it automatically . . . instantaneously . . . for both AM and FM. Switchable controls permit symmetrical (FM) or asymmetrical (AM) peak limiting; pre-emphasized or flat response; compress/limit, compress only, or compress/limit off. Automatic gain control range is 40 dB dynamic, and the compression ratio is better than 10:1. All solid state, plug-in modular construction assures trouble-free reliability. Write for complete details.

**BROADCAST ELECTRONICS, INC.**  
 A Filmways Company  
 8810 Brookville Rd., Silver Spring, Md. 20910

## FM monaural FREQUENCY and MODULATION monitor

**TBM-3700**  
**\$1350**

built in calibration  
sca/stereo add on  
am fm s/n and  
remote metering  
or complete information  
please contact  
the Director of Sales  
Dept. B-37



**McMartin** · MCMARTIN INDUSTRIES INC., 605 NORTH THIRTEENTH STREET  
 OMAHA, NEBRASKA, 68102 TELEPHONE (402) 342-2753

Circle 136 on Reader Service Card

# Ever feel like the White Rabbit on his way to the Mad Hatter's tea party?

Any broadcast station runs on a tight schedule. In fact, your clock may be the most important piece of equipment you have. And lots of clocks aren't everything they could be. So lots of stations end up worrying about the time. Just like the White Rabbit.

That's why we've developed the DIGIT-SYNC™ Clock/Timer System. It keeps all your clocks on time and synchronized. Real or lapsed. On a 12 or 24 hour format. And it never loses more than three seconds per year.

The DIGIT-SYNC Master Clock synchronizes impulse clocks, 60-Hz clocks, event timers, station breaks, programs, and as many of its own digital or round faced slave clocks as you need. An optional built-in character generator is available. In fact, the modular design of the DIGIT-SYNC System allows you to expand it from a single clock to a clock system of virtually any size or complexity.

The only thing you don't get with the DIGIT-SYNC System is a lot of complicated wiring. Time data and power supply are transmitted by built-in modems via a single pair of shielded wires. Time information can be recorded on your tape recorder.

And, incidentally, if the power fails, it switches to an external battery. Automatically.

So if you're in a time bind, don't be a White Rabbit. Get a DIGIT-SYNC Clock/Timer System or arrange for a demonstration.

**TFT** TIME & FREQUENCY TECHNOLOGY INC.

2950 Scott Boulevard, Santa Clara, California 95050 (408) 246-6365

Circle 138 on Reader Service Card



## PERFECT YOUR CCTV SYSTEM WITH COSMICAR® LENSES



TV-COSMICAR-EE 16mm F/1.6

The TV-COSMICAR-EE 16mm f/1.6 is a high-speed lens specially designed for 2/3" vidicon cameras. It maintains image luminance 100 lx against subject brightness between LV11.3 ~ 17 (350 ~ 18,000 cd/m<sup>2</sup>), about 1,800 ~ 96,000 lx.

The automatic electric-eye diaphragm close down completely provided that subject brightness exceeds approx. LV20 (144,000 cd/m<sup>2</sup>), 768,000 lx. In case the camera is switched off and not in operation, the automatic diaphragm closes down, completely shutting off the light for protection of the vidicon camera.

The "Change-over Switch" in front of the lens controls the operation of the diaphragm.

When the switch lever is turned on to "EE", the lens diaphragm operates as fully automatic electric-eye. and is brought on to "OPEN", the diaphragm stays fully opened condition.

**Be sure to get the finest image recording results with quality Cosmicar lenses.**

Also available are scores of other lenses, ranging from 8.5mm to 1,000mm telephoto, zoom and those motordriven among them, for immediate delivery, after being tailored to your specifications.



**COSMICAR OPTICAL CO., LTD.**

424, Higashi-Oizumi, Nerima-ku, Tokyo, Japan

Cable Address: "MOVIEKINO TOKYO"

Circle 137 on Reader Service Card



trickiest and requires the most subjective testing in order to arrive at a worthwhile end result. There are basically two types of active equalizers on the market that will do the job for the broadcaster; the peaking type and the shelving type. Fig. 3 shows the difference in operation of the two. What the station must decide is what particular frequencies, or range of frequencies, must be emphasized in order to enhance the type of program material being broadcast. It has been found, for example, that a station with a modern pop music format can enhance its on-air sound by employing a few dB of peaking at 5KHz to make the sound "brighter." In order not to sound overly "tinny" because of the 5KHz emphasis, a peaking boost of a few dB at 300Hz should also be applied. The amount of emphasis and the frequencies to be emphasized in each individual broadcast operation will depend on the results of a number of listening tests but, once a determination has been arrived at, the overall sound of the station will benefit.

Let us now look at the combination of the three methods to get an idea of their total effect on transmitter modulation and listener quality. Fig. 4 is a simplified block diagram of a broadcast audio hookup, from microphone to transmitter, showing all the methods discussed and their normal placement with-

in the system. Beginning at the left of the diagram, it can be seen that a certain amount of equalization can be employed at the source, thereby allowing selection as to what is equalized and how it is done. A small peak at 2.5 to 3KHz can be added to the microphone input to the console, for instance, to add more "presence" to the announcer's voice. This can greatly improve the characteristics of some ribbon microphones, which are known to be deficient in this area. A simple and inexpensive circuit like that in Fig. 5 will help give that little "extra" to enhance the live sound of the voice on the air.

Similarly, selective equalization can be added to other sources reaching the main audio console, such as tape recorders and turntables. A little trick that can be done with some turntables is to increase the speed ever so slightly in order to give the recorded music a "brighter" sounding quality. Increasing the speed increases the pitch of the music and can produce a very interesting subliminal effect. Needless to say this should be done with a very light hand, since too much of an increase can lead to some very weird results.

If you want to equalize the whole program, it is recommended that this be inserted after the main audio console. In the diagram we have indicated, for an example, a peaking boost of 2 dB at 300Hz and 5KHz. The equalizer should be installed either patchable or switchable so that A/B (before/after) checks can be made while trying to set up a proper curve or for routine periodic checks of the system.

## MEET THE LITTLE SISTER OF OUR WP-11...the compact WV-063

waveform & picture monitor combo for less than what you've paid for a WFM alone



### Ultra Audio Products

Request Bulletin No. **BM 11-72**

Box 921 • Beverly Hills • California 90213 • (213) 849-1433

Circle 139 on Reader Service Card

## "RAPID-Q"



### check these STANDARD features...

- ✓ High speed cueing (RAPID-Q)
- ✓ Heavy duty cast head-mounts
- ✓ Reliable direct drive servo-capstan motor
- ✓ 1000 and 150 Hz cues standard
- ✓ IC switching and IC audio—NO relays
- ✓ Automatic audio muting
- ✓ Compact size (3 1/2" height)

## "RAPID-Q"

1216 KIFER ROAD  
SUNNYVALE CALIF. 94086  
(408) 736-8737

Circle 151 on Reader Service Card

As mentioned earlier, restricting the bandwidth of the transmitted signal will allow a considerable increase in the total audio power received by the listener while retaining the overall quality of the program material. This can be done even before an equalization curve is set up so that there will be a basis from which to begin other processing. The diagram shows a frequency response between 100Hz and 7.5KHz. A high pass filter cuts off any frequency below 100Hz, and a low pass filter cuts off any frequency above 7.5KHz. These filters are commercially available and can be installed directly in the 600-ohm program line but, because they are unbalanced devices, careful grounding techniques must be employed when inserting them into a balanced program line.

It has been found in practice (once again referring to Fig. 4) that the limitation of the transmitted frequency response and any equalization of the audio signal should be accomplished before entering the AGC amplifier. The reason is rather simple. Since the AGC unit will only limit the dynamic range of the soon-to-be transmitted audio signal, what signal should be as close to a finished product as possible.

Careful consideration to the adjustment of the AGC unit can provide extremely worthwhile results. Experimentation with different threshold settings and amounts of gain reduction will enable the broadcaster to achieve a better idea of his signal capabilities and allow him to choose the right set-

tings for his particular type of programming.

From the AGC amplifier the signal is usually fed to a peak limiter, another kind of signal processor which eliminates any excessively strong peaks in the audio waveform. This unit, in most cases, will reduce excessive peaks without distortion only up to a certain level. If the peaks exceed that level the limiter will begin to clip the waveform, producing distortion. It should be noted that if a very large amount of equalization is employed at some points in the frequency spectrum, this clipping condition is more likely to be reached. Therefore, the broadcaster must consider carefully the signal levels reaching each item of equipment, as compared with the capabilities of that item. This also applies to the last link in the chain, the transmitter. It must have enough signal capacity to handle the extra work demanded by the signal processing. This means keeping a watchful eye on its performance and a regular maintenance schedule to insure its continued uninterrupted service.

At this point it can be seen that putting a particular format on the air takes a little work on the technical side too, if the broadcaster is to reap the full benefits of his programming labors. The end result of all the above machinations should be a transmitted audio signal with the ingredients not only to assure a higher average percentage of modulation, but also to make the sound a more pleasurable experience for the listener and a more appealing commodity for the broadcaster. **BM/E**

*Where can you get this quality and all these features  
— at this price?*

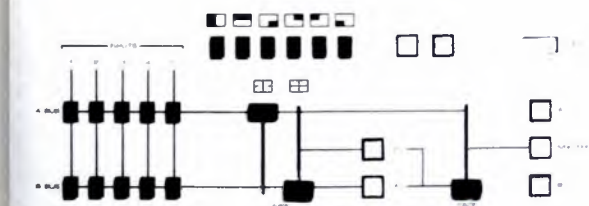

VISCOUNT MODEL 1120 PROGRAMMER

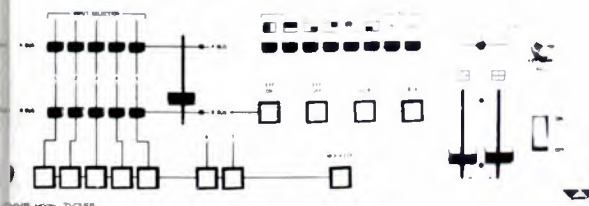

VISCOUNT MODEL 7V3

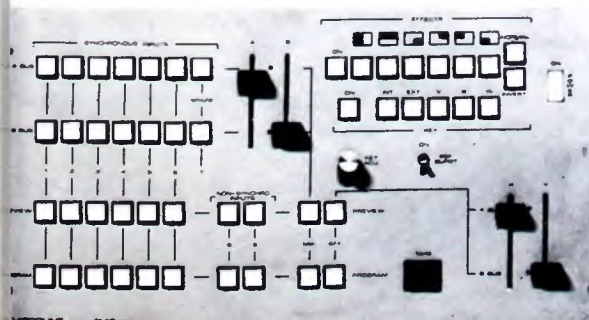

VISCOUNT MODEL 1140

All you need to produce the best T.V. programs. All these programmers feature full colour compatibility; fade, split screen, six adjustable, reversible wipe patterns; VIS on all illuminated push buttons. No double selections possible. One year warranty on parts and labour.

Two program outputs, one preview output, and one black; the 1120 enables preview of fades, supers and effects such as a corner insert with an on-air source. All inputs tip of sync clamped; tally standard. **\$995**

Features matte, key (external or internal), fade to key or effects. The 7V3 is fully contained in 7 inches of rack space. A special circuit prevents minor timing errors causing "hooking" in the effects patterns; tally standard. **\$1970**

The 1140 features 3 camera keying; Composite or non-composite inputs; split electronic faders; reference burst input; operates from internal or external sync; hard back porch clamp on all signals; time compensated re-entry. Remote control panel 10½ inches high.

**\$4950**

*Where?*



VISCOUNT VIDEO SYSTEMS LTD.,  
Marine Industrial Centre  
105 East 69th Avenue  
Vancouver 15, British Columbia, Canada  
Phone: (604) 327-9446 Telex 04-508605

Circle 140 on Reader Service Card

www.americanradiohistory.com



# Technical Papers Presented at the 1972 NAB ENGINEERING CONFERENCE



Now—the complete volume of Technical Papers presented at the 1972 National Association of Broadcasters Engineering Conference—available in durable, bound format, typeset in uniform style.

This complete transcript includes the technical papers presented at the Conference, plus a transcript of the FCC-Industry Panel discussion. It is profusely illustrated, containing all the photos, slides and drawings presented in conjunction with the technical talks. The presentations, all by industry experts, constitute a virtual encyclopedia on the current state of all phases of radio-TV broadcast engineering.

Here is a volume that belongs on the shelf of every station library—something every broadcast engineer should read...and re-read...several times. It's a wonderful source of ideas, and provides the answers to many troublesome problems. Invaluable as an aid in helping stations make important buying and engineering decisions.

The Proceedings is 184 pages, 8½ x 11", and is bound in durable vinyl for convenient use. The Special Prepublication Price of \$7.95 prevails through Dec. 15, 1972; thereafter the regular list price is \$10.00. Three copies or more ordered at one time obtain a 10% discount.

## LISTING OF CONTENTS

**NAB ENGINEERING ADVISORY COMMITTEE REPORT**—Benjamin Wolfe (Chairman), Post-Newsweek Stations, Wash. D.C.  
**STATUS OF PENDING FCC DOCKETS**—James D. Parker, CBS Television Network, New York, N.Y.  
**FCC-INDUSTRY TECHNICAL PANEL**—Moderator: Albert H. Chismark, Broadcasting Division-Meredith Corp., Syracuse, N.Y.  
**MODERNIZING ANTENNA FACILITIES AT WSAU**—Robert A. Jones, Consulting Engineer, La Grange, Ill.  
**GATES PDM TRANSMITTERS—HIGH LEVEL PLATE MODULATION WITHOUT MODULATION TRANSFORMERS OR REACTORS**—Hilmer Swanson, Gates Radio Co., Quincy, Ill.  
**DESIGN FEATURES OF THE AUTOMATED WINS TRANSMITTER PLANT**—Bruce H. Ratts, WINS Radio, New York, N.Y.  
**CONTROLLING THE EFFECTS OF PARASITIC RERADIATION ON DIRECTIONAL ANTENNAS**—John H. Battison, Carl E. Smith Consulting Radio Engineers, Cleveland, Ohio  
**QUADRAPHONIC SOUND PANEL**—Moderator: Edward H. Herlihy, Kaiser Broadcasting Corp., Boston, Mass.  
**CIRCULAR POLARIZATION FOR TELEVISION SIGNALS**—Lewis D. Wetzel, Shively Laboratories, Inc., Raymond, Me.  
**A PORTABLE FILM SYSTEM FOR DEMONSTRATING BENEFITS OF USING FILM FOR TELEVISION**—John A. Pistor, Eastman Kodak Co., Rochester, N.Y.  
**TRANSLATORS, THE BROADCASTER'S OBLIGATION**—Vincent E. Clayton, Bonneville International Corp., Salt Lake City, Utah.  
**NEW TECHNIQUE FOR DIFFERENTIAL GAIN AND PHASE CALIBRATION OF BROADCAST DEMODULATORS**—John Venczel, Telemet, Amityville, N.Y.  
**CINEMATTE I: A SPECIAL EFFECTS BREAKTHROUGH**—Albert E. Busch, Sarkes Tarzian, Inc., Bloomington, Ind.  
**A BROADCASTER'S EXPERIENCE WITH VIDEO CARTRIDGE TAPE RECORDERS**—Francis Jacob, Jr., WWL, New Orleans, La.  
**THE NEXT STEP IN TELEVISION STATION AUTOMATION**—Thomas M. Jordan, Jr., et al, General Electric Co., Syracuse, N.Y.  
**INFLUENCE OF RF OUTPUT SYSTEMS ON TV TRANSMITTER PICTURE QUALITY**—Thomas M. Gluyas, RCA, Camden, N.J.  
**HIGH POWER UHF TRANSMISSION**—Edward H. Herlihy, Kaiser Broadcasting Corp., Boston, Mass.  
**NOISE REDUCTION IN QUARTZ HALOGEN LAMPS**—R. P. Bonazoli and R. Hebert, GTE Sylvania Inc., Danvers, Mass.  
**A PICTURE SOURCE SYNC GENERATOR**—Robert D. Post, NBC  
**THE IMPROVEMENT OF COLOR TV TRANSMISSION**—Frederick C. Everett, Consulting Engineer, Ft. Lauderdale, Fla.

## PUBLISHER'S GUARANTEE

Put the information in this book to work for you for 10 days. If it doesn't prove to be worth several times its cost, return it and we'll cancel invoice.

## NO RISK COUPON—MAIL TODAY

TAB Books, Blue Ridge Summit, Pa. 17214  
 Please send me \_\_\_\_\_ copies of "Technical Papers Presented at the 1972 NAB Engineering Conference" at the special prepublication price of only \$7.95. (10% discount on 3 copies or more.)  
 I enclose \$\_\_\_\_\_  
 Please invoice on 10-day FREE trial  
 Name \_\_\_\_\_  
 Company \_\_\_\_\_  
 Address \_\_\_\_\_  
 City \_\_\_\_\_ State \_\_\_\_\_ Zip \_\_\_\_\_  
 SAVE POSTAGE by paying with order.  
 Foreign add 10%. Pa. add 6% tax. B-112

## FCC RULES continued from page 16

programming supply for independent stations—particularly "still-struggling UHF independents upon which Congress and the Commission have relied for a fully competitive nationwide television broadcast service."

For this reason, the Commission decided that the public interest required a limit on network control and an increase in "truly independent sources" for development of prime time programs. It said by limiting the amount of programming by affiliates in the top 50 markets to three hours between 7 and 11 p.m., it was providing a "healthy impetus" to independent program sources.

The Commission stated, however, that it was not carving out a "competition-free haven for syndicators." At the same time it pointed out that the public interest did not permit preservation of "the non-competitive enclave now occupied in prime time by the television networks." No licensee would be required to carry syndicated programs if he did not choose to do so. He could develop his own programs or use locally originated shows to fill his schedule.

An additional factor in providing a more competitive market is the requirement prohibiting the networks from owning or distributing programs produced by sources other than the network itself. In the market existing prior to adoption of the new rules, a producer was required to bargain for exhibition with the networks, which are also his competitors, and that many agreements required producers to give up valuable distribution rights in return for the network purchase of programs. The Commission decided that the new rule would greatly enhance the producer's ability to operate profitably in network television. Additionally, prohibiting the networks from syndicating their own programs would make for fairer competition by eliminating the advantage the networks have because of their existing affiliate relations.

The rules also provide that a producer may reacquire a program from a network if it has not made use of the program within a reasonable time. This would prevent a network from tying up a program which could be used in non-network markets.

The new rules do not require divestiture of current holdings by the networks; however, the Commission emphasized that it would continue to survey the operation of the rules and if the "public interest is adversely affected" it would take "prompt remedial action."

The Commission concluded that the networks should take the lead "in encouraging the inclusion of the feasible maximum of independently controlled and independently provided programs in their schedules." It cited rulings by Judge Learned Hand and Justice Bryan White calling for a system "which will most stimulate and liberate those who create and produce television programs and those who purvey them to the public."

The Commission's objective is to create an arena of more adequate competition among existing and potential program producers. Judging from the schedule of programs presented in the top markets, the Commission appears to have accomplished the desired results.

BM/E





# Spindler & Sauppé TV film chain 2x2 projectors

your widest  
*and wisest* choice

Seven models in all — one of which will fit your needs *exactly*. Color or monochrome; uniplex or multiplex; forward or reverse actuation; sequential or random access; 16- to 96-slide capacity. These are thoroughly proved performers, built to the highest professional standards, and recently updated with advanced electronics.

For complete information, write  
**Spindler & Sauppé**, 13034 Saticoy St.,  
North Hollywood, Calif. 91605;  
phone (213) 764-1800.



**SPECTRUM 32B:** The most advanced film chain slide projector available. For color or monochrome chains; 32-slide capacity. Many exclusives. Operates at 120V, 50/60 Hz. Spectrum 32F operates at 220V, 50/60 Hz.



**MODEL 332:** Newest version of the work-horse of the industry. For monochrome chains, 32-slide capacity. Model 322 single turret for 16 slides, monochrome or color.



**MODEL SLX-TV:** 96-slide capacity, random access. Model SLS-TV 48-slide, random access. Model SLD-TV 96-slide, sequential. Model SLR-TV 48-slide, sequential, forward/reverse. All for monochrome or color chains.

Circle 142 on Reader Service Card

## accurate measurement of the fourth dimension

Standard Electric Time has developed and manufactured units for the precise measurement of elapsed time since 1932. These panel mounted or portable units are available in several models with accuracies to plus or minus one millisecond. They can be connected to electrical or electronic circuits for remote start, stop and reset.

For full details request catalog 261.



PANEL MOUNTED



PORTABLE

Model	Scale Divisions	Totalizes	Accuracy
S-100	1/5 sec.	6000 sec.	±.1 sec.
S-60	1/5 sec.	60 min.	±.1 sec.
SM-60	1/100 min.	60 min.	±.002 min.
S-10	1/10 sec.	1000 sec.	±.02 sec.
S-6	1/1000 min.	10 min.	±.0002 min.
S-1	1/100 sec.	60 sec.	±.01 sec.
MST-100	1/1000 sec.	6 sec.	±.001 sec.
MST-500	1/1000 sec.	30 sec.	±.002 sec.

**STANDARD  
ELECTRIC TIME**  
DIVISION OF JOHNSON SERVICE COMPANY



89 LOGAN STREET, SPRINGFIELD, MASSACHUSETTS 01101

Circle 143 on Reader Service Card

## SPECIAL SALE STUDIO CRANES



Just released from Warner Brothers, these incomparable, reconditioned "Academy" Cranes, familiar to the industry as "Grey Ghosts" are designed for studio use with all cameras. Used on scores of Emmy-winning programs, they are extremely silent and smooth. Equipped with hydraulic column and mechanical balance arm — complete with remote control and weights. From floor level to 9'. 110-volt d.c. forward and reverse. At a fraction of original cost. **SAVE THOUSANDS!** Get one now at only \$3,500.\*

\*Camera and geared head not included.



**BIRNS & SAWYER, INC.**  
1026 NORTH HIGHLAND AVENUE  
LOS ANGELES, CALIFORNIA 90038 • (213) 466-8211

Circle 144 on Reader Service Card





**1** Model OIB-1 Operating Impedance Bridge measures "in circuit" impedance of networks, transmission lines and antennas. Accuracy -5% -1 Ohm. 5 kW Power rating-VSWR 3:1.



**2** Model CPB-1 Common Point Bridge measures resistance to -2% -1 Ohm and reactance to -5% -1 Ohm at full power.



**3** Model RG-1 Receiver/Generator combines a high output power signal generator with a shielded receiver for use with Model OIB-1 or any other impedance bridge.

# THE DELTA TRIO

for optimum  
monitoring  
of your  
antenna  
system

With this "Delta Trio", you can either "spot check", or continuously and accurately monitor actual "on-the-air" operating impedance of transmission lines, networks and antenna systems to maintain a "clean signal" at peak operating efficiency.

If you're operating with a directional antenna, there's real value in being able to keep the radiating system in close adjustment at all times...continuously verify common point impedance to insure full power output...plus locating and correcting any antenna problems—fast!

Complete details and application data are available without obligation—just write or call Bill Cottles,

**DELTA ELECTRONICS**



Exporter: DELTA ELECTRONICS, INC.  
International Division, 154 E Boston Post RD  
Mamaroneck, N. Y. 10543, Telex 1 37327, Art Rocke  
Circle 145 on Reader Service Card

## MEASUREMENT continued from page 33

crowave carriers and the Long Lines division of ATT.

It is impossible to determine the source of a transmission distortion. ANSWER processors, located at affiliate inputs, interchange points in the common carrier network, and at the input and output of satellite feeds, can send by telephone lines information on the nature of the signal to network headquarters. A transmission supervisor can have a display of the VITS from any point on the network before him in 35 seconds. Immediate corrective action can be initiated.

Expanding to the use of the computer, a network transmission computer could automatically pool the various ANSWER processor locations on the network and store pertinent data for later analysis.

Out-of-limit situations are easily recognized and the computer can signal the need for corrective action. Perhaps it is not too far in the future that we will find network computers alerting common carrier computers to make adjustments in signal quality. The ANSWER computer could then confirm that a correction had taken place. Such futuristic use of computers to aid in the transmission of television signals is not terribly far fetched. The degree of software sophistication is really limited only by the imagination of the programmer. Cost savings can accrue to the user of such an automatic system by decreasing down time, determining trends of failures, and scheduling maintenance.

BM/E

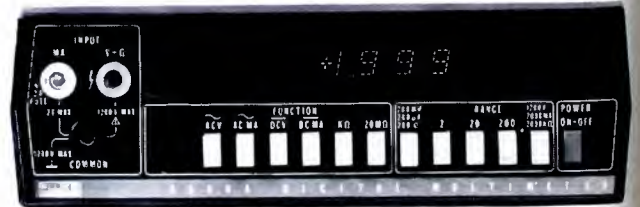

## **\* New digital V.O.M. \$299**

- 26 ranges to measure ac/dc voltages from 100 microvolts to 1200 V, ac/dc currents from 100 nanoamperes to 2 amperes and resistance from 100 milliohms to 20 megohms.
- Guaranteed to stay within specifications for one full year. Fluke gives you the best specs and strongest warranty on the market today for the lowest cost of ownership ever.
- Wide choice of options including rechargeable battery pack, digital printer output, deluxe test leads, high-voltage probe, RF probe, 200-amp ac current probe, carrying case, dust cover and rack mounts.
- Unique self-zero feature eliminates offset errors.
- Rugged high-impact case with securely mounted internal electronics.
- Service centers throughout U.S., Canada, Europe and Far East for 48-hour turnaround repairs.



P. O. Box 7428,  
Seattle, Washington 98133.

Get all the details from your nearest Fluke sales office. Dial toll-free 800-426-0361 for address of office nearest you.

Circle 146 on Reader Service Card



# BM/E CLASSIFIED MARKETPLACE

## CLASSIFIED ADVERTISING RATES

DISPLAY CLASSIFIED ADVERTISING: \$22.50 per inch 1x; \$22.00 per inch 3x; \$21.00 per inch 6x; \$20.00 per inch 12x. ALL OTHER CLASSIFIED ADVERTISING 25¢ per word; minimum \$3.00. BLIND BOX NUMBER: No extra charge. Replies sent to address below will be forwarded to you. PAYABLE IN ADVANCE; send check with order. CLOSING DATE: 5th of 2nd month preceding issue date.

BM/E, Monterey and Pinola Avenues, Blue Ridge Summit, Pa. 17214

Phone 717/794/2191

### HELP WANTED

#### VIDEO TECHNICIAN

Major Midwestern CATV System heavily involved in local origination needs a video technician who is a self-starter and needs little supervision. Strong background in helical scan VTRs a must. System is an innovator in local origination. State salary requirements with complete resume. Reply to Box 1172-1

BM/E, Blue Ridge Summit, Pa. 17214

Assistant Director of Instructional Communications Center in new University. In charge of production graphics, films, audio, photo, and television and electronic distribution of programs via sophisticated network including several channels CATV. Five years experience as production manager or equivalent. M.A. Required. Minorities encouraged. Salary: \$16,000 to \$19,000 depending on qualifications. University Professorship possible. Available February, 1973. Warland D. Wight, Instructional Communications Center, Governors State University, Park Forest South, Illinois 60466. 312/563-2211.

SPECIAL PROJECTS ENGINEER—to help install and maintain new TV color and new FM equipment. First phone and installation/maintenance experience required. WJCT (TV-FM), 2037 Main St., Jacksonville, Florida. 904/354-2806.

SALESMAN. Carrier minded. Established station. Salary, commission. Send resume, billing record. KRFO, Longview, Texas. 75601.

### EQUIPMENT FOR SALE

SEC CUSTOM AUDIO CONSOLES at prices comparable manufacturers' standard units. Modern styling with vertical slide potentiometers and "soft" audio switching. Completely assembled or save even more on console kit. Call or write for custom quotation. Also, plug-in audio modules, distribution amplifiers, preamplifiers, active combining networks, monitor amplifiers. Write or call for brochure. S. E. Company, P.O. Box 49224, Atlanta, Ga. 30329. 404/631-3586.

CARTRIDGE TAPE EQUIPMENT—Rebuilt. New paint, heads, flywheel, pressure roller, belts etc. Spotlessly clean and thoroughly tested. 30 day money-back guarantee, 90 day warranty. Also contact us for possible discounts on new equipment and accessories.

AUTODYNE, Box 1004, Rockville, Maryland 20850 (301/762-7626).

#### MOTORS FOR SPOTMASTERS

NEW Papst hysteresis synchronous motor HSZ 20.50-4-470D as used in series 400 and 500 machines. Price \$39.00 each prepaid while they last. 90 day warranty. Terms check with order only, no COD's. Not recommended for Tapecaster series 600 or 700.

TAPECASTER TCM, INC., Box 662, Rockville, Maryland 20851

SCULLY TAPE RECORDERS: Mono, 2, 4, 8, 12, & 16 track models plus 270 automatic players. Some models in stock now. W.A.'s custom audio control console & console modules. Solid state 120 Watt power Amps. We buy and rebuild Scully lathes. WIFGAND AUDIO LABORATORIES, INC. R.D. 3, Middleburg, Pa. 7842, 717-837-1444.

Solid-state audio modules-console kits, power amplifier kits, power supplies. Octal plug-ins—mic, eq. line, disc, tape play, tape record, amplifiers. Audio & tape bias oscillators. Over 50 audio products. Send for free catalog and applications. Opamp Labs, Inc., 172 So. Alta Vista Blvd., Los Angeles, Calif. 90036. (213) 334-3566.

COAXIAL CABLE—jacketed 3 inch air dielectric heliax-270 feet—Andrew's #HJ8-50A/Miht. RG322U—fitted with 2 male, factory installed. 1/4" flanges. Excellent condition. \$1,300. Write/call WKJF, Inc., 1715 Grandview Ave., Pittsburgh, Pa. 15211. 412/381-8100.

FIELD STRENGTH METER. 540 KHz to MHz. Ten microvolts to 10 volts per meter. New solid state design, long battery life. Stable accurate calibration. Free literature. Solar Electronics, 901 No. Highland Ave., Hollywood, Cal. 90038.

AMPEX 300, 350, 352, 400, 450 users, for greater S/N ratio, replace first playback stage 12S17 with our plug-in transistor preamp. For specification write VIF INTERNATIONAL, PO Box

### EQUIPMENT FOR SALE (cont'd)

AMERICA'S LARGEST STOCK AND ASSIGNMENT LISTING of new and used broadcast and recording equipment. We trade-sell and buy. THE MAZE CORPORATION, P.O. Box 6636, Birmingham, Ala. 35210.

SPARTA 600CRP & 600CP-RK stereo cartridge playback and recorder both with 150 Hz & 8 KHz aux cue. One year old in excellent condition. KZST (FM) Box 2755, Santa Rosa, Calif. 95405. 707/528-4434.

140' Galvanized Self-supporting Antenna Towers. Weight 7.5 tons, base 12 sq. ft. tapering to 1 sq. ft. at top. Wind load 145 M.P.H. Logan Cablevision, Box 185, Snow Shoe, Pa. 16874. 814/387-4961.

Used RCA-50G, 50,000 Watt AM Transmitter. Excellent condition—very clean. Now in operation. Reply to Box 1172-2, BM/E, Blue Ridge Summit, Pa. 17214.

The complete and reliable source for new and used broadcast equipment. Request our free listings. Broadcast Equipment and Supply Co., Box 3141, Bristol, Tennessee 37620.

Mica and vacuum capacitors. Price lists on request. Surcom Associates, 1147 Venice Blvd., Los Angeles, Ca. 90015, (213) 362-6985.

One stop for all your professional audio requirements. Bottom line oriented. F.T.C. Brewer, Box 8057, Pensacola, Fla. 32505.

4—650 ft. towers \$6500.00 each. Many more. Ground wire 85¢ per xx. lb. Bill Angle, Box 55, Greenville, N.C. 27834. Tel. 919-752-3040.

Surplus Audio Patch Panels All Standard Configurations. Gulf Telephone & Electronics, Inc. 6235 Beverly Hill, Houston, Texas 77027.

B & H Videotape. 1/2" x 2400". List \$39.95, 54% off. \$18.50. AGE, Inc. 5362 Caluenga Street, North Hollywood, Calif.

### PROGRAM SERVICES

# TAPES FOR AUTOMATION

**THE CnB STUDIOS**  
Specializing in Custom Services

3415 BERESFORD AVENUE  
BELMONT, CALIFORNIA 94002  
415 / 592-6149

"Free" Catalog . . . Everything for the deejay! Comedy, books, airchecks, wild tracks, old radio shows, and more! Write: Command, Box 26348-A, San Francisco 94126.

### TECHNICAL SERVICES

CUSTOM CARTRIDGE RELOADING and refurbishing. Fidelipac replacement parts and cartridges. Write us today for prices. PROFESSIONAL AUDIO SERVICES, BOX 1953, FT. WORTH, TEX. 76101.

### CONSULTANTS

COHEN & DIPPELL  
CONSULTING ENGINEERS  
Formerly GEO. C. DAVIS  
527 Munsey Bldg.  
(202) 783-0111  
Washington, D. C. 20004  
Member AFCCCE

JANSKY & BAILEY  
TeleCommunications Consulting  
Department  
CATV & CCTV  
Phone 703/354-2400  
Shirley Hwy. at Edsall Rd.  
Alexandria, Virginia 22314  
Atlantic Research Corporation

### CONSULTANTS (cont'd)

VIR JAMES  
CONSULTING RADIO ENGINEERS  
Applications and Field Engineering  
Computerized Frequency Surveys  
345 Colorado Blvd.—80206  
(303) 333-5562  
DENVER, COLORADO  
Member AFCCCE

McCLANATHAN & ASSOCIATES  
consulting engineers  
Applications & Field Engineering  
Turnkey Installations—Radio & TV  
Domestic & Foreign  
P.O. Box 750  
Portland, Oregon 97207  
Phone: 503/246-80c0

### BROADCAST STUDIO DESIGN

Control Systems, Facilities Planning,  
Plant Layout & Manufacturing

DYMA ENGINEERING, INC.  
Route 1, Box 51, Taos, New Mexico 87571  
Phone: 505/758-2686

### INSTRUCTIONS

FCC FIRST CLASS RADIOTELEPHONE LICENSE IN SIX WEEKS. Classes in El Paso, Dallas, Atlanta, Chicago, Cincinnati, Denver, Ft. Worth, Hartford, Houston, Memphis, Miami Beach, Milwaukee, Minneapolis, Nashville, New Orleans, Oklahoma City, St. Louis, San Antonio, San Francisco, and Seattle. For information contact Elkins Institute, 2727 Inwood Rd, Dallas, Tex. 75235 214/357-4001.

First phone through tape recorded lessons at home plus one week personal instruction in Washington, D.C., Atlanta, Boston, Detroit, New Orleans, Minneapolis, Seattle, Denver, Portland, Los Angeles. Proven results. Our 17th year teaching FCC license courses. Bob Johnson Broadcast License Training, 1060D Duncan, Manhattan Beach, Calif. 90266. 213-379-4461.

ATTENTION VETERANS! First class license in five weeks with complete theory and R.C.A.-equipped laboratory training. Approved for veterans Tuition \$333.00. Housing cost \$16.00 per week. American Institute of Radio, 2622 Old Lebanon Road, Nashville, Tenn. 37214. 615-889-0469.

### FRANCHISES

## CATV FRANCHISE

The City of Columbia, S. C. (Population 113,000) is requesting bids for a 15 year CATV franchise to be awarded in the summer of 1973.

Address inquiries to:  
City of Columbia  
City Manager  
City Hall  
P. O. Box 147  
Columbia, S. C. 29202



# SBC-415 TAKES THE WORRY OUT OF MEETING AURAL PROOF-OF- PERFORMANCE

That's right. Our SBC-415 FM Subcarrier is the sound duplexer system that guarantees peace of mind when you sign-off your aural proof-of-performance statement.

SBC-415 adds a big margin of safety to your TV-STL operation because it's first in extra low distortion, (0.5%, maximum); first in video interference rejection.

SBC-415 combines ultra-linear modulation and highly selective demodulation with a precise 60 dB isolation delay equalized filter system.

We designed it that way to meet your most critical broadcast requirements. SBC-415 is a unique departure from ordinary subcarrier design that delivers unequalled performance at a price that's right.

But, see for yourself. Write for the facts, today. Better still, call us.



534 Twentieth Street • Oakland, CA 94612 • Telephone: (415) 465-5900

Circle 147 on Reader Service Card

## ADVERTISERS' INDEX

Ampex Corporation	13
Audio Devices, Inc.	Cover 3
Audio-Video Engineering Co.	54
Birns & Sawyer	61
Blonder-Tongue Laboratories, Inc.	CM/E-12, 13
Broadcast Electronics, Inc.	55, 56
CCA Electronics Corporation	42
Canon Inc.	49
Canon U.S.A. Inc.	9
Capital Audio Tapes	Cover 3
Charles Machine Works Inc.	47
Cosmicar Optical Co., Ltd.	57
Datatron Inc.	10
Delta Electronics, Inc.	62
Ditch Witch, A Division of Charles Machine Works, Inc.	47
Dynair Electronics Corp.	3
Eastman Kodak Co.	39
Fidelipac, A Div. of TelePro Industries Inc.	53
Fluke	62
Fort Worth Tower Co., Inc.	64
GTE Sylvania, Lighting Center	50, 51
Garron Electronics	58
General Cable Corp.	CM/E-14, 15
Grass Valley Group, Inc., The	5
Heller-Oak Finance Corp.	CM/E-9
International Tapetronics Corp.	8, 48
Jampro Antenna Corp.	28
Jerrold	CM/E-2
LPB Inc.	12
McMartin Industries Inc.	53, 56
Oak Industries Inc., CATV Division	CM/E-11
Philips Broadcast Equipment Corp.	14, 15
RCA	17, 18, 19, 20
Rapid Q	58
Rohde & Schwarz	45
Scientific-Atlanta	7
Scott-Buttner Coastcom	64
Shibaden Corporation of America	36, 37
Shively Labs., Inc.	54
Shure Brothers, Inc.	43
Sitco Antennas	CM/E-16
Spindler & Sauppé	61
Standard Electric Time Division of Johnson Service Company	61
Superscope Inc.	44
Systems Wire & Cable Inc.	CM/E-5
Systron-Donner, Concord Instruments Div.	Cover 4
Systron-Donner, Microwave Div.	11
TAB Books	60
Telex Communications Division	46, Cover 2
Television Equipment Associates	56
Terracom, A Division of Conic Corp.	52
Time & Frequency Technology Corp.	57
Tracor Inc.	12
Ultra-Audio Products	58
U. S. Computer Systems, Inc.	CM/E-7
Viscount Video Inc.	59
Wilkinson Electronics Corp.	40

## SALES OFFICES

Broadband Information Services, Inc.  
274 Madison Avenue  
New York, New York 10016

### EASTERN STATES

274 Madison Avenue  
New York, New York 10016  
212-685-5320

Charles C. Horner

### MIDWESTERN STATES

New York Office

### WESTERN STATES

1111 Hearst Building  
San Francisco, California 94130  
415-362-8547

William J. Healey

16400 Ventura Blvd.  
Encino, California 91316  
213-981-4721

Art Mandell

### JAPAN

Nippon Keisoku Inc.  
P.O. Box 410  
Central Tokyo, Japan  
536-6614

Yoshi Yamamoto

# THE LEADER IN CATV TOWERS

"Quality—Service  
and Price!"



Yes, quality, service and price on CATV systems are the reasons for Fort Worth Tower's position as the industry's leading supplier. Experience gained as a pioneer supplier of CATV enables Fort Worth Tower to provide you with a quality product at a price that is reasonable and attractive.

Take advantage of our experience. For assistance in systems planning, engineering and complete systems quotations . . .

CALL OR WRITE TODAY

## Fort Worth Tower

COMPANY, INCORPORATED

P.O. Box 8597, Fort Worth, Texas  
(817) JE 6-5676

—Associated Companies—  
Tommy Moore, Inc.  
Big State Engineering, Inc.  
Tower Construction Finance, Inc.

Circle 150 on Reader Service Card

## USE BM/E's CLASSIFIED MARKETPLACE TO REACH OVER 26,000 BROADCASTERS!

Please run my ad in BM/E's CLASSIFIED MARKETPLACE in your next:

- 12 issues       6 issues  
 3 issues         1 issue

Name .....

Station or Co. ....

Address .....

City ..... State .....

BM/E, Classified Advertising Department, Blue Ridge Summit, Pa. 17214.  
717/794-2191. (Enclose check.)



# BM/E READER SERVICE CARD/November, 1972 Issue

Use this FREE post-paid card for more information on the products described.

TELL US WHAT YOU LIKE OR DISLIKE ABOUT THIS ISSUE:

NAME \_\_\_\_\_ TITLE \_\_\_\_\_

STATION OR COMPANY \_\_\_\_\_

ADDRESS/CITY \_\_\_\_\_

STATE \_\_\_\_\_ ZIP \_\_\_\_\_

WHAT ARTICLES WOULD YOU LIKE TO SEE?

100-199: ADS / 200-274: LIT / 275-440: EDITORIAL

USE UNTIL JANUARY 31, 1973

100 101 102 103 104 105 106 107 108 109 110 111 112 113 114 115 116 117 118 119 120 121 122 123 124 125 126 127 128 129 130 131 132 133 134 135  
136 137 138 139 140 141 142 143 144 145 146 147 148 149 150 151 152 153 154 155 156 157 158 159 160 161 162 163 164 165 166 167 168 169 170 171  
172 173 174 175 176 177 178 179 180 181 182 183 184 185 186 187 188 189 190 191 192 193 194 195 196 197 198 199  
200 201 202 203 204 205 206 207  
208 209 210 211 212 213 214 215 216 217 218 219 220 221 222 223 224 225 226 227 228 229 230 231 232 233 234 235 236 237 238 239 240 241 242 243  
244 245 246 247 248 249 250 251 252 253 254 255 256 257 258 259 260 261 262 263 264 265 266 267 268 269 270 271 272 273 274  
275 276 277 278 279  
280 281 282 283 284 285 286 287 288 289 290 291 292 293 294 295 296 297 298 299 300 301 302 303 304 305 306 307 308 309 310 311 312 313 314 315  
316 317 318 319 320 321 322 323 324 325 326 327 328 329 330 331 332 333 334 335 336 337 338 339 340 341 342 343 344 345 346 347 348 349 350 351  
352 353 354 355 356 357 358 359 360 361 362 363 364 365 366 367 368 369 370 371 372 373 374 375 376 377 378 379 380 381 382 383 384 385 386 387  
388 389 390 391 392 393 394 395 396 397 398 399 400 401 402 403 404 405 406 407 408 409 410 411 412 413 414 415 416 417 418 419 420 421 422 423  
424 425 426 427 428 429 430 431 432 433 434 435 436 437 438 439 440

# BM/E READER SERVICE CARD/November, 1972 Issue

Use this FREE post-paid card for more information on the products described.

TELL US WHAT YOU LIKE OR DISLIKE ABOUT THIS ISSUE:

NAME \_\_\_\_\_ TITLE \_\_\_\_\_

STATION OR COMPANY \_\_\_\_\_

ADDRESS/CITY \_\_\_\_\_

STATE \_\_\_\_\_ ZIP \_\_\_\_\_

WHAT ARTICLES WOULD YOU LIKE TO SEE?

100-199: ADS / 200-274: LIT / 275-440: EDITORIAL

USE UNTIL JANUARY 31, 1973

100 101 102 103 104 105 106 107 108 109 110 111 112 113 114 115 116 117 118 119 120 121 122 123 124 125 126 127 128 129 130 131 132 133 134 135  
136 137 138 139 140 141 142 143 144 145 146 147 148 149 150 151 152 153 154 155 156 157 158 159 160 161 162 163 164 165 166 167 168 169 170 171  
172 173 174 175 176 177 178 179 180 181 182 183 184 185 186 187 188 189 190 191 192 193 194 195 196 197 198 199  
200 201 202 203 204 205 206 207  
208 209 210 211 212 213 214 215 216 217 218 219 220 221 222 223 224 225 226 227 228 229 230 231 232 233 234 235 236 237 238 239 240 241 242 243  
244 245 246 247 248 249 250 251 252 253 254 255 256 257 258 259 260 261 262 263 264 265 266 267 268 269 270 271 272 273 274  
275 276 277 278 279  
280 281 282 283 284 285 286 287 288 289 290 291 292 293 294 295 296 297 298 299 300 301 302 303 304 305 306 307 308 309 310 311 312 313 314 315  
316 317 318 319 320 321 322 323 324 325 326 327 328 329 330 331 332 333 334 335 336 337 338 339 340 341 342 343 344 345 346 347 348 349 350 351  
352 353 354 355 356 357 358 359 360 361 362 363 364 365 366 367 368 369 370 371 372 373 374 375 376 377 378 379 380 381 382 383 384 385 386 387  
388 389 390 391 392 393 394 395 396 397 398 399 400 401 402 403 404 405 406 407 408 409 410 411 412 413 414 415 416 417 418 419 420 421 422 423  
424 425 426 427 428 429 430 431 432 433 434 435 436 437 438 439 440

# COMPLIMENTARY SUBSCRIPTION QUALIFICATION CARD

1. I would like to receive BM/E  Yes  No  
I would like my copies to include CM/E  Yes  No

Name \_\_\_\_\_ Title \_\_\_\_\_

Station or Co. \_\_\_\_\_

Street \_\_\_\_\_

City \_\_\_\_\_ State \_\_\_\_\_ Zip \_\_\_\_\_

2. My company is: (Please check ALL items which pertain to your firm.)

- AM Station(s)  Program Sources or Recording Studios  
 FM Station(s)  Government  
 TV Station(s)  Consultant  
 Instructional or Closed Circuit TV or Campus Limited Radio  Lawyer  
 CATV Facilities  Distributor/Manufacturer dealer  
 Telephone Company  Other (please specify) \_\_\_\_\_

If this is an address change, affix label

3. Are you responsible for more than one station or facility?  
 Yes  No

Is this your business address?  Yes  No

4. My primary area of responsibility is: (Please check one)

- Corporate Management  Station, Production or Program Management  
 Engineering & Engineering Management  Other (please describe) \_\_\_\_\_  
 Operations Management

If not, please give us your business address below so that we can avoid sending duplicate copies.

Name \_\_\_\_\_

Station or Co. \_\_\_\_\_

Street \_\_\_\_\_

5. Your signature \_\_\_\_\_



# BUSINESS REPLY MAIL

NO POSTAGE STAMP NECESSARY IF MAILED IN THE UNITED STATES

POSTAGE WILL BE PAID BY



Broadband Information Services, Inc.

P.O. BOX 6058

Duluth, Minnesota 55806

**FIRST CLASS**

Permit No. 665  
Duluth, Minnesota



# BUSINESS REPLY MAIL

NO POSTAGE STAMP NECESSARY IF MAILED IN THE UNITED STATES

POSTAGE WILL BE PAID BY



Broadband Information Services, Inc.

P.O. BOX 6058

Duluth, Minnesota 55806

**FIRST CLASS**

Permit No. 665  
Duluth, Minnesota



# BUSINESS REPLY MAIL

NO POSTAGE STAMP NECESSARY IF MAILED IN THE UNITED STATES

POSTAGE WILL BE PAID BY



Broadband Information Services, Inc.

P.O. BOX 6056

Duluth, Minnesota 55806

**FIRST CLASS**

Permit No. 665  
Duluth, Minnesota





**"When I suggested  
to the staff that we try  
out other cartridges,  
they were unanimously  
against it."**

— Ernie McDaniel, Director,  
Technical and  
Broadcast Operations,  
WCBS Newsradio 88

"We're an all-news station.  
Cartridges are one  
of our basic tools.  
A substantial portion  
of our programming  
is on carts.

"We've got to be able  
to depend on them.

"We use Audiopaks exclusively.  
Our people prefer them.

"A few years ago,  
we had a problem with  
cartridges. We talked  
to the Audio engineers.  
We worked with them  
to come up with  
the present Audiopak.  
We're happy with it.

"With a weekly audience  
of 2,305,800 (according  
to the latest ARB),  
we'd better have  
dependable cartridges."

**New  
Audiopak<sup>™</sup> A-2  
Broadcast  
Cartridges**

Audio Devices, Inc.  
Capital Industries Company  
7 Research Drive  
Danbury, Conn. 06906

[www.americanradiohistory.com](http://www.americanradiohistory.com)



**Sensitivity 10 mV**

**Stabilities to  $\pm 5$  parts in  $10^{10}/24$  hrs.**

**Battery option**

**\$770 up, delivery 30 days**

All models frequency expandable  
Resolution to 9 digits or 0.1 Hz  
Small size, 3½" H, ½ rack W  
BCD output for systems use  
Remote programming



\$770



\$1,050



\$1,395



\$2,295

Now choose from the industry's widest selection of **frequency counters!** For details or a demo, contact your Scientific Devices office or Concord Instrument Division, 10 Systron Dr., Concord, CA 94520. Phone (415) 682-6161. In Europe: Systron-Donner GmbH Munich W-Germany; Systron-Donner Ltd., Leamington Spa UK

SYSTRON  DONNER

The Systron-Donner Instruments Group:

Alpha Scientific  Computer Systems  Concord Instruments  Datapulse  Kruse Electronics  Microwave  Trygon Electronics

Circle 149 on Reader Service Card

[www.americanradiohistory.com](http://www.americanradiohistory.com)